



INSTALLATION GUIDE

SLATTED CLADDING

CONTENTS

STORAGE & HANDLING	03	INSTALLATION - SOFFIT	32
SAFETY & USE	04	INSTALLATION - GABLE END	36
TOOLS	05	INSTALLATION - SECRET DOOR	39
CALCULATING MATERIAL	06	INSTALLATION - ROOF	44
COLOURS AND EFFECTS	07	INSTALLATION - SCREEN OR PLANTER	49
SLATTED CLADDING COMPONENTS	08	CLEANING AND CARE	53
CLADDING ACCESSORIES	09	EXPANSION GAP TABLE	54
PRE INSTALLATION NOTES	10		
INSTALLATION METHODS	11		
INSTALLATION - FACADE SYSTEM - HORIZONTAL	12		
INSTALLATION - FACADE SYSTEM - VERTICAL	27		

STORAGE & HANDLING

Whilst our composite materials are highly durable we do recommend you follow the below guidelines for storage, handling and installing, to ensure products are kept in the best possible condition.

STORAGE

- Materials should be stored under cover in shade, and protected from weather until ready to install.
- Materials should be covered and kept dry until ready to install to ensure a clean surface. Products should not be stored outside and or covered with plastic sheeting.
- All composite products should be stored supported above the ground at 500mm intervals on a flat clean surface. Supporting battens used in storage should align through the stack to equally transfer the load.
- Cladding panels must be stacked on top of each other
- Where multiple pallets are delivered these should not be stacked higher than 3m per stack.
- tekBoard will not be held responsible for issues that arise from poor storage.

HANDLING

- Cladding materials should be placed and not dumped when unloading. Boards should be lifted and set down with care to avoid damage. Do not slide boards over one another.
- Cladding boards should be carried in the middle and on their edge for best support when moving.
- During installation, avoid sliding or dragging any equipment across the board surface to avoid tarnishing the surface
- The surface of the cladding boards should be kept free of construction debris and material to prevent damage to the boards. As with all sites, surfaces should be kept clean and tidy for the best installation outcome.

SAFETY & USE

Prior to installing any composite system we recommended that you consult local building regulations for any special requirements or restrictions that may apply. The illustrations and accompanying instructions in this guide are for illustrative purposes to provide a typical installation scenario, and do not replace the advice of a licensed professional in the field.

SAFETY

- Personal Protection Equipment (PPE) should be worn at all times (COSHH Assessment summary available). When cutting and installing boards it is advised to wear gloves, protective eye wear, a dust mask, long sleeves and trousers.

- Dry and windy environments may result in a naturally occurring static build-up in composite products. The level of static build up will not cause personal injury.

- All composite cladding boards MUST be installed on a substructure to allow adequate air flow behind - this prevents any excessive water absorption. Boards cannot be laid directly onto a flat surface. A minimum of 25mm clearance behind the cladding should be provided to allow adequate drainage and drying.

- Excessive heat may be felt on the surface of the composite cladding products from external sources such as reflection of sunlight from Low-E glass. This may cause an unusual heat build-up on any exterior surfaces. Excessive heat exposure may cause: boards to sag or warp, expansion/ contraction at increased levels, accelerated weathering, and in extreme circumstances melt the board surface.

Note - A rise to such adverse levels is deemed extremely unlikely in the UK due to the stable climate.

USE

- Standard woodworking tools can be used to install our composite products. When using a chop saw we would recommend a 60T+ Multipurpose Aluminium blade for maximum efficiency and neatness on cuts.

- Plan a layout for your cladding before starting to ensure the best looking layout is achieved. Pay particular attention to interfaces with doors, windows and soffits in order to determine the optimal starting position for the first boards.

- Slatted Composite Cladding Boards are not intended for use as columns, support post, beams, joist stringers or other primary load-bearing members.

- Boards must be supported by a compliant substructure and CANNOT be installed onto existing cladding boards.

- All fixings should be fastened at a 90° angle to the cladding system.

- Use white chalk, straight boards or string lines as templates. NEVER use coloured chalk on the boards as this can cause permanent staining.

- All recommended fixings are available. Please consult with the technical department for further advice.

TOOLS

RECOMMENDED TOOLS TO INSTALL SLATTED CLADDING

Standard woodworking tools can be used when working with tekBoard Slatted Cladding. If you are unsure on how to use any tool, please consult the tool's manufacturer's user manual.

- Circular Saw - we recommend a 60T+ Aluminium / laminate multipurpose blade to achieve the cleanest cuts.
- Mitre Saw extremely useful
- Jig Saw
- Hand Drill
- 3mm and countersink drill bits (SmartBit countersink tool available)
- Tape Measure
- Set Square
- String line
- Spirit Level
- Protective eye wear and relevant Personal Protection Equipment (PPE)
- Pencil

CALCULATING MATERIAL

To determine how much tekBoard Cladding material will be required, you can either use detailed plans and elevations, or follow the method below.

Step 1. Measure the length of trims.

First work out what type of trims you will require, and how many linear meters you need. We offer two finishing trims with the slatted cladding range - End trim and a Corner trims. They both come in 3600mm lengths so divide the total length required by that number. You may have extra waste on areas where you prefer no joints.

Example:

Corner Trim
Total Length 50m / 3600mm = 13.8 or 14 Trims

End Trim
Total Length 14m / 3600mm = 3.8 or 4 Trims

Step 2. Measure the m2 area of boards

To work out how many cladding boards you need, first measure the m2 area of the wall or screen you're trying to build, and times that by 8.93. Then divide that number by 3600mm to work out the number of individual boards you need.

Example:

Number of cladding boards
 $55\text{m}^2 \times 8.93 = 492.8$ lin meters

$492.8\text{m} / 3600\text{mm} = 136.8$ or 137 boards

(2.48 slatted cladding boards at 3.6m lengths = 1 m2 of area)

Total amount:

137 Cladding Boards
14 Corner Trim Boards
4 End Trim Boards
4 x boxes of cladding clips
4 x packs of wood screws for cladding clips.
Stainless Steel 316 colour coded screws.

(Fixings and screws which are available in packs of 500)

Note: Laying boards vertically may lead to additional waste, depending on wall height. Please factor this into your considerations. Offcuts can always be used above/below windows and above doors.



COLOURS AND EFFECTS

tekBoard Composite Cladding is available in 3 colours and can be laid either vertically or horizontally:

AVAILABLE COLOURS



SPICED OAK



SILVER BIRCH MIDNIGHT



ORIENTATION (THIS MANUAL EXPLORES BOTH OPTIONS)



Horizontal

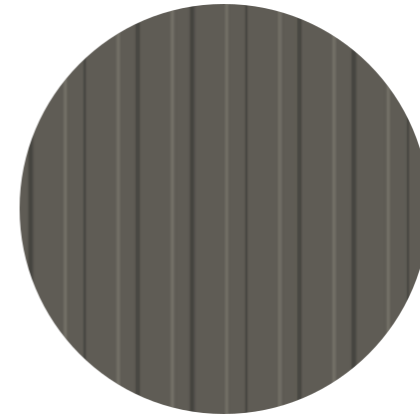

Vertical

SLATTED CLADDING COMPONENTS

Please ensure you are familiar with all the cladding components prior to starting.

Slatted Cladding Board

(25 x 121 x 3600mm)



Corner Trim

(45x78x3600mm)



End Trim

(75 x 54 x 3600mm)



CLADDING ACCESSORIES

Please ensure you are familiar with all the cladding accessories and fixings prior to starting.

Aluminium Cladding Clips (250pcs)



Solid Plastic Joists

(50x50x2400mm)

Or treated timber / aluminium joists
(see below)

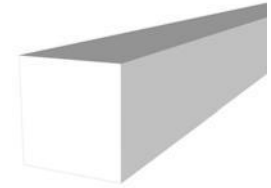

Aluminium Cladding Starter Bar (3000mm)

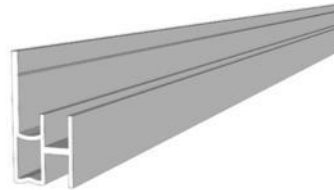

Black powder coated aluminium joists

(40x40x3600mm)



Wood Screws for Cladding Clips (500pcs)



Plastic Pad (18x8mm)



Stainless Steel 316 Colour Coded screws



Screw for Aluminium (500pcs)



PRE INSTALLATION NOTES

SPACING BOARDS & JOISTS

- Due to the natural expansion and contraction of the composite material with changes in ambient temperature and humidity cladding boards should be installed with an expansion gap between adjoining boards. Refer to table on page 54 for distances.
As an example; If installing whole length cladding boards (3600mm long), and the air temperature at time of install is 21°C - the expansion gap should be 4.4mm between adjoining boards - as noted in expansion gap table.
- Plastic or timber joists should be installed with a 20mm gap between ends.
- A minimum 15mm gap should be provided between the lowest cladding board edge and the ground.
- A clear cavity between the rear face of the cladding and the outer wall/ surface of the structure being clad should be provided of no less than 25mm to allow sufficient airflow.
- Joists should be no more than 500mm from centre to centre.
- Extra care is required in order to provide sufficient joisting around windows, fascia's, soffits, guttering, ventilation points and corners of walls. These locations should be planned and co-ordinated with the Cladding system to ensure alignment with the composite fascias and trims. This will allow fixing of the cladding & end trims back to the joists.
- A double joist arrangement will be required for mid panel joints and at corners to allow the joint trims to be seated and fixed to both joists. Consider expansion and contraction as shown on page 54.
- Note that netting, or foam can be used behind boards to prevent insect nesting.

JOIST SPECIFICATION:

- Cladding can be fixed to solid plastic, pressure treated softwood timber (in accordance with BS8417), or Aluminium joists depending on design requirements. Both solid plastic joists and aluminium joists can be purchased from tekBoard.
 - Joists should be fixed into position at 500mm centres using suitable A4 stainless steel countersunk wood/ masonry screws or good quality exterior screws. All joists need to be fixed in a minimum of 3 places.
 - All joists need to be minimum 19mm thick, flat and leveled against the wall. Use shims as required.
 - Joists used at external corners should be at least 50mm wide to accommodate the Corner / End Trims and provide space for the Aluminium Cladding Clips to be fixed.
 - External Corner Joists: min 19mm thick x 50mm wide
 - Standard Joists: min 19mm thick x 38mm wide
- *** Prior to installation, a building professional should be consulted regarding vapor barriers and insulation for your project. Where a vapor barrier is to be used, it should be a breathable type and must be positioned behind the joists to allow the cladding a minimum 25mm airflow. It is essential that a barrier/ coating is installed to prevent water penetration.

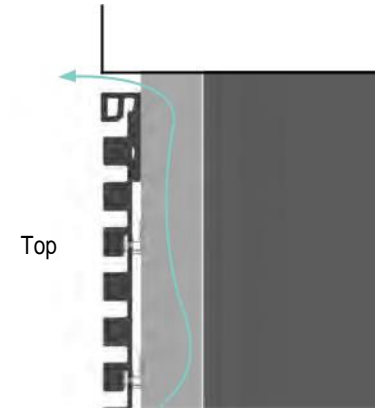

Ventilation zone behind cladding

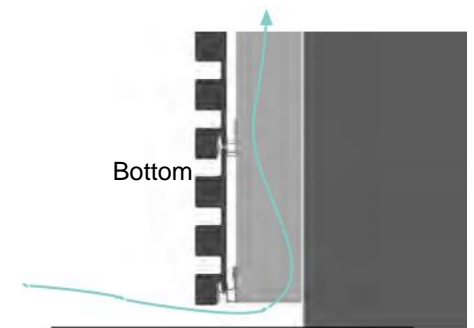

Primary ventilation from bottom

INSTALLATION METHODS

Slatted Cladding can be used in a wide variety of applications such as a cladding detail for a house, commercial building or garden room as well as a decorative screen, cladding of garden walls and much more. However it is worth noting that it is only meant to be viewed from one side, not from two sides as a fence would be. Think carefully about whether an alternative product may be better suited to your design needs if two sides will be visible. For more information please call the office or visit our website.

In this manual we will demonstrate installation with two common methods for using Slatted Cladding, fixing to a facade, and fixed to a free standing structure to create a screen or planter box.



FACADE SYSTEM

Fixed to a block wall or similar

Please refer to pages:

- 12-26 For horizontal laying
- 27-31 For vertical laying
- 32-35 For a typical soffit detail
- 36-38 For a typical gable end detail
- 39-43 For a typical 'secret door' detail
- 44-48 For a typical roof detail



SCREENING SYSTEM

Fixed to a timber frame structure, creating a screen or planter

Please refer to pages:

49-52

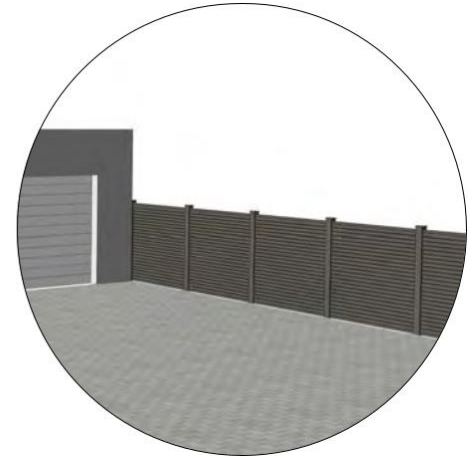

FENCING SYSTEM

Slatted cladding can be used for fencing, but a more cost effective method is to use our Fencing range.

INSTALLATION - FACADE SYSTEM - HORIZONTAL

STEP 1

LINE THE WALL AND INSTALL THE JOISTS

- A Ensure the wall is in suitable condition for the system to be fixed onto. tekBoard can take no responsibility for inadequately constructed walls.

Line the wall with a waterproof membrane / vapor barrier and fix in place. For specifications please contact your architect or contractor.

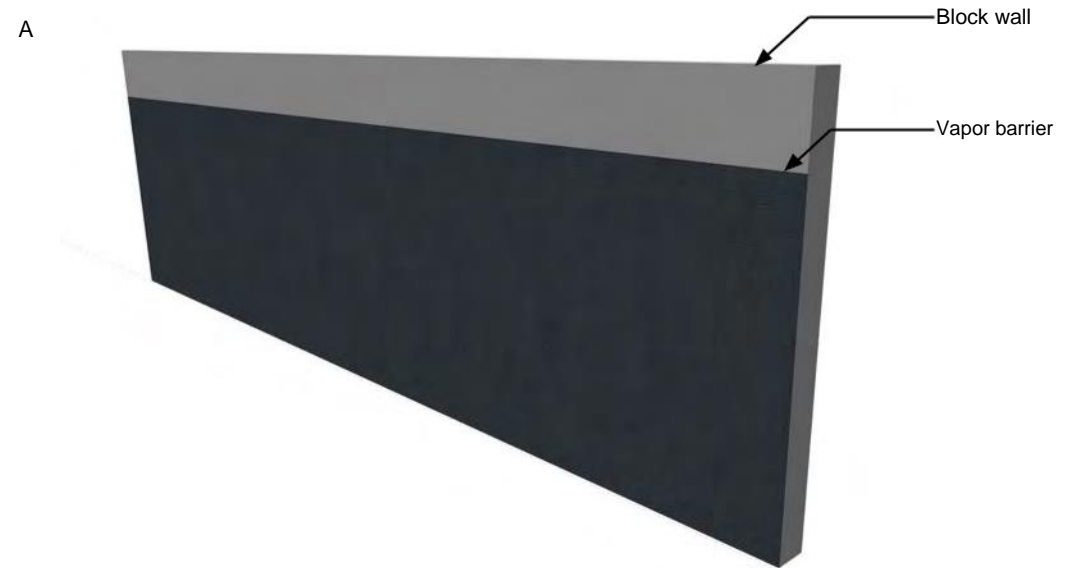

- B Fix treated timber battens to the wall to create the sub frame. Joists should be spaced at 500mm centres using suitable A4 stainless steel countersunk wood/ masonry screws. We recommend pre drilling and fixing the battens every 500mm, try to fix into the centre of the blockwork or panel and avoid mortar joints where possible.

All joists should be flat and leveled against the wall, using shims as required. Solid plastic joists or aluminium joists can also be used.

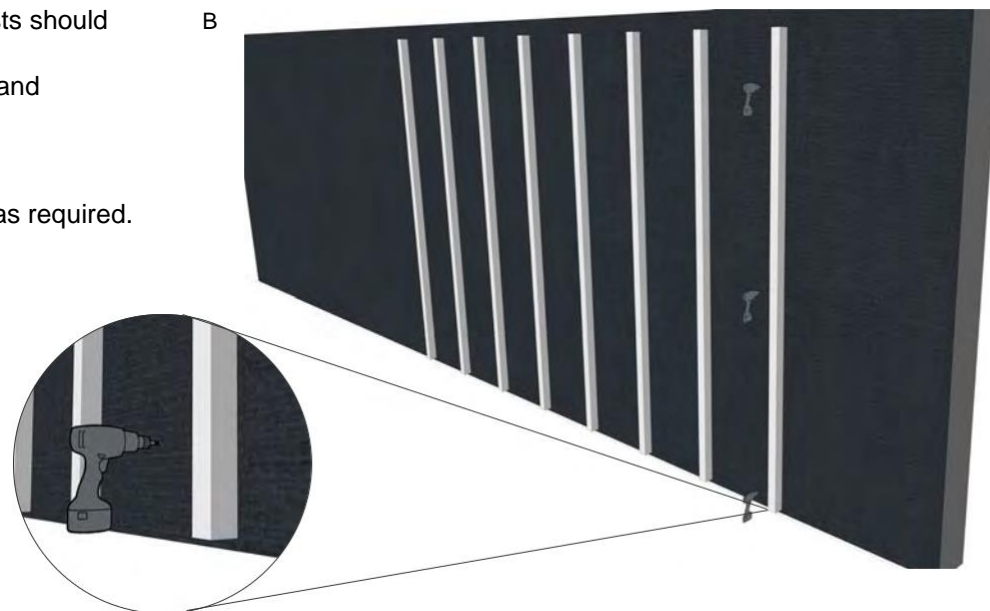

INSTALLATION - FACADE SYSTEM - HORIZONTAL

STEP 2

INSTALL JOISTS TO CORNERS AND EDGES

C Install joists to the corners to allow the trims to be fixed later.

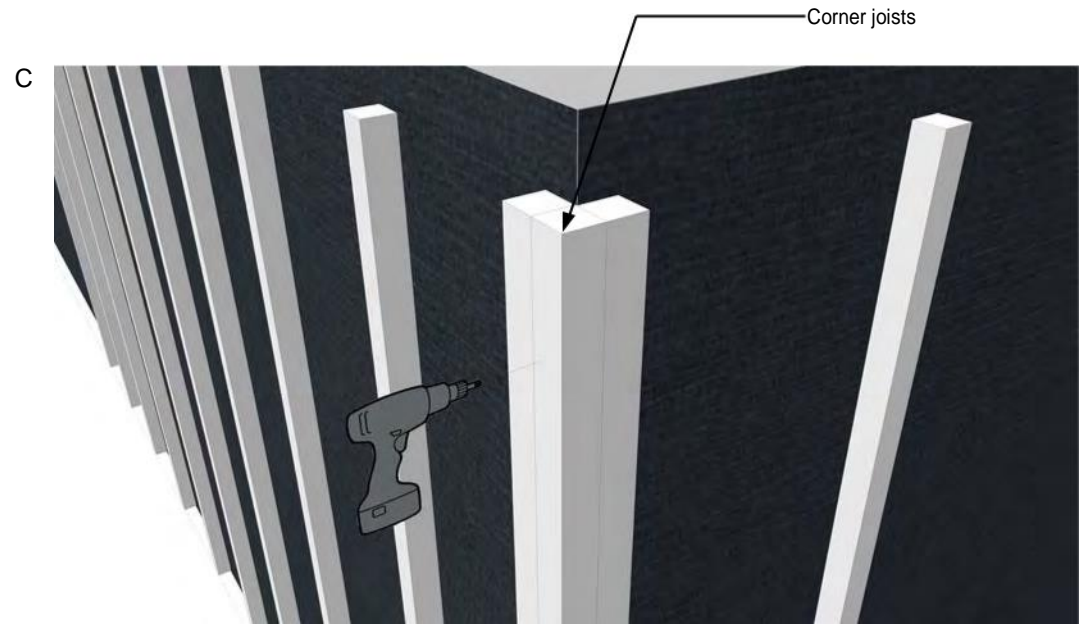

D Install top joists where end trims are to be used - the top joist is not vital - you could have the vertical joist longer. Customer has the option.

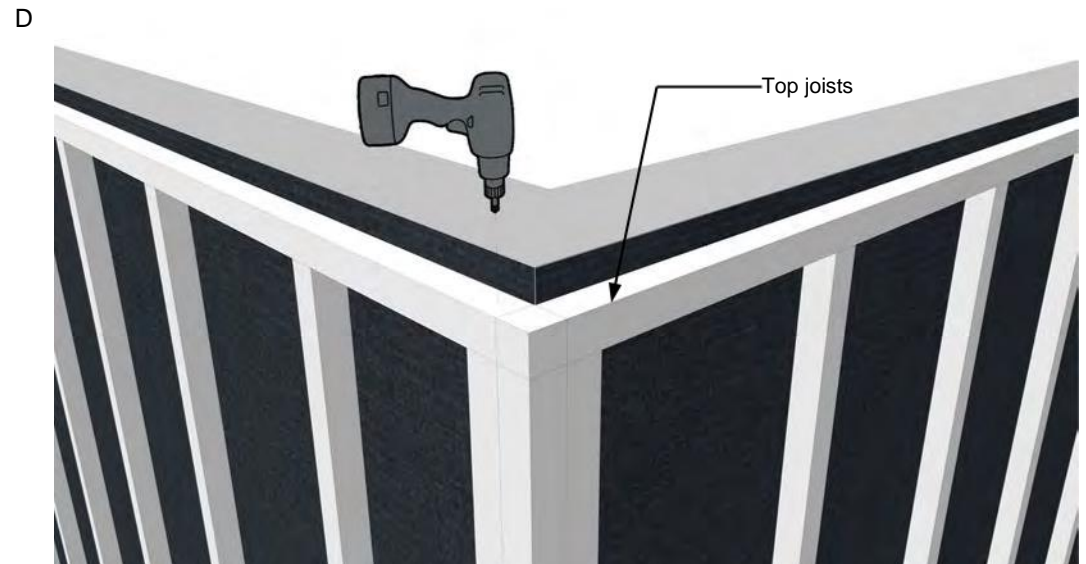

INSTALLATION - FACADE SYSTEM - HORIZONTAL

STEP 3

INSTALL THE CORNER AND END TRIMS

Before the cladding boards can be installed we must first install the corner and end trims. Fix these to the joists using wood screws, pre-drill and countersink the screws for a flush finish. We recommend fixing points every 500mm.

It is recommended that one complete section is installed at a time to help align boards and ensure consistency.

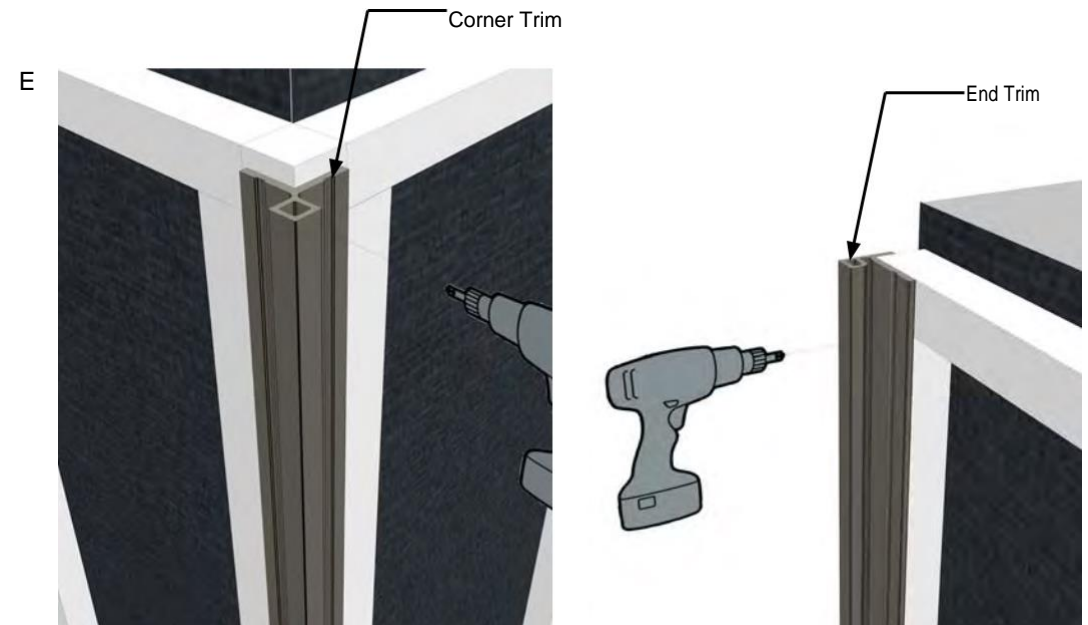

End trims to the top of the wall can be fixed at the start, however ensure you have calculated the number of boards and spacings required to avoid unnecessary cutting.

There is a small recess groove on the trim where we recommend to screw into as shown below.

Corners can be mitered to create a neat picture frame.

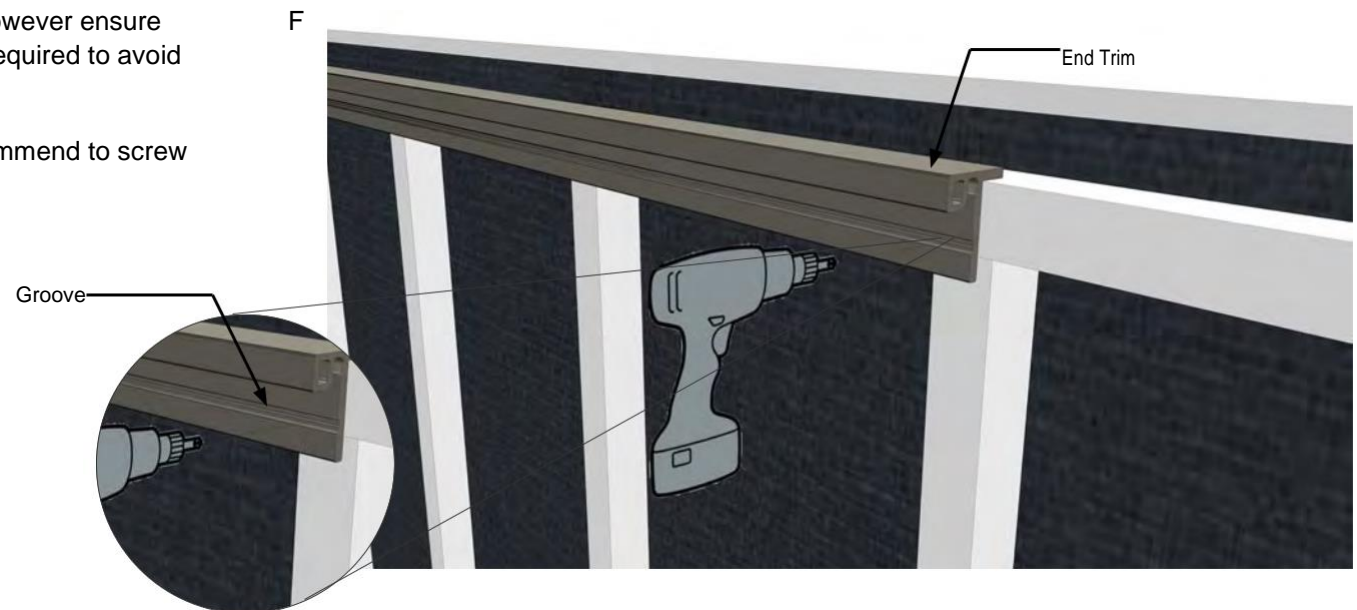

INSTALLATION - FACADE SYSTEM - HORIZONTAL

STEP 4

FIX THE ALUMINIUM CLADDING STARTER BAR

- G Fix the Aluminium cladding starter bar to the base of the joists every 500mm (into each batten).

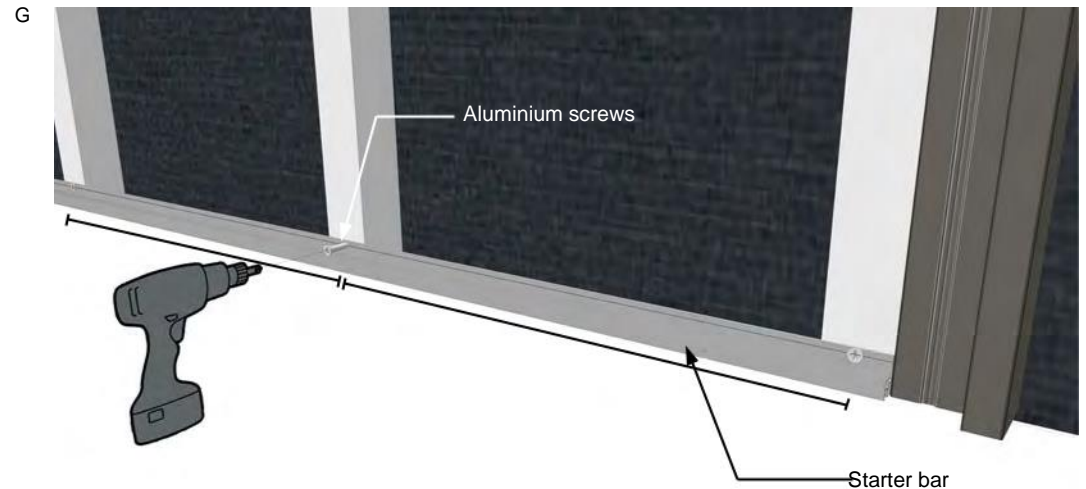

- H Ensure that the starter bar is level and sufficiently secured.

Please note that all cladding boards should be no closer than 15mm to the ground.

Note - If the cladding is to be installed higher up the building, you may wish to use a corner or end trim as this looks better than the starter bar when seen from below. Refer to page 28.

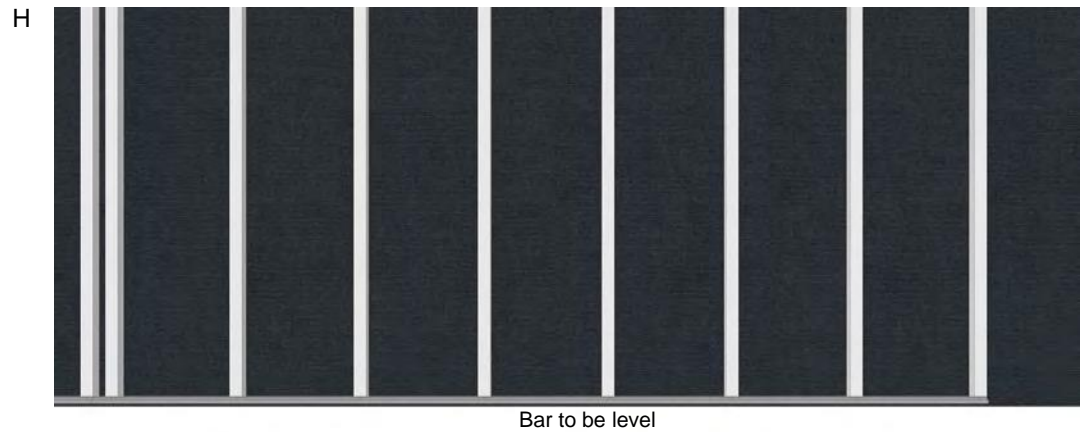

INSTALLATION - FACADE SYSTEM - HORIZONTAL

STEP 5

INSERT THE FIRST CLADDING BOARD

- I Take a cladding board and place the side with the lip down onto the starter bar.

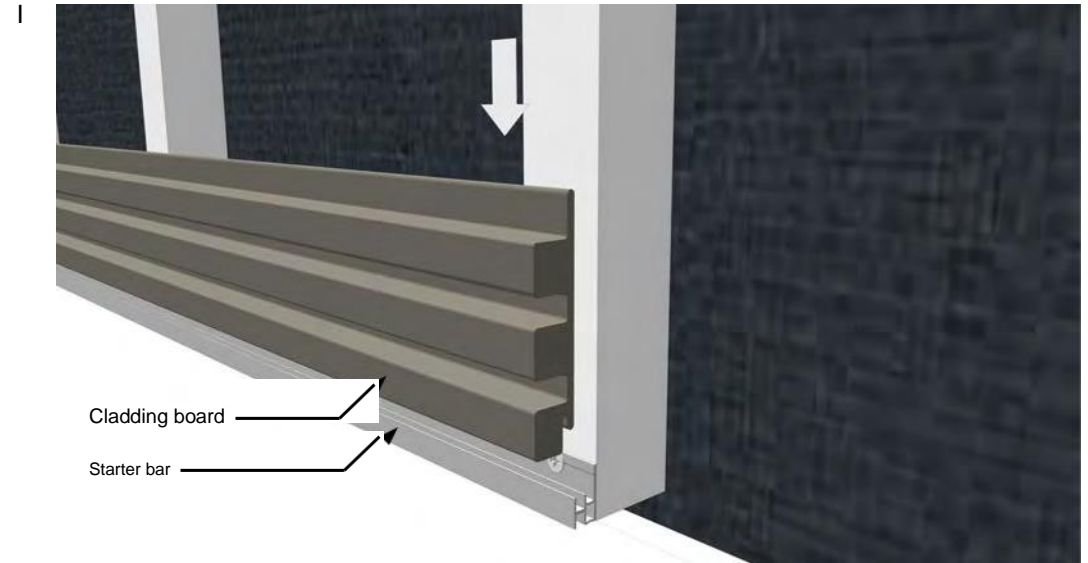

- J Press down firmly on the board to slot it into place. Ensure it is level and connected properly all the way along.

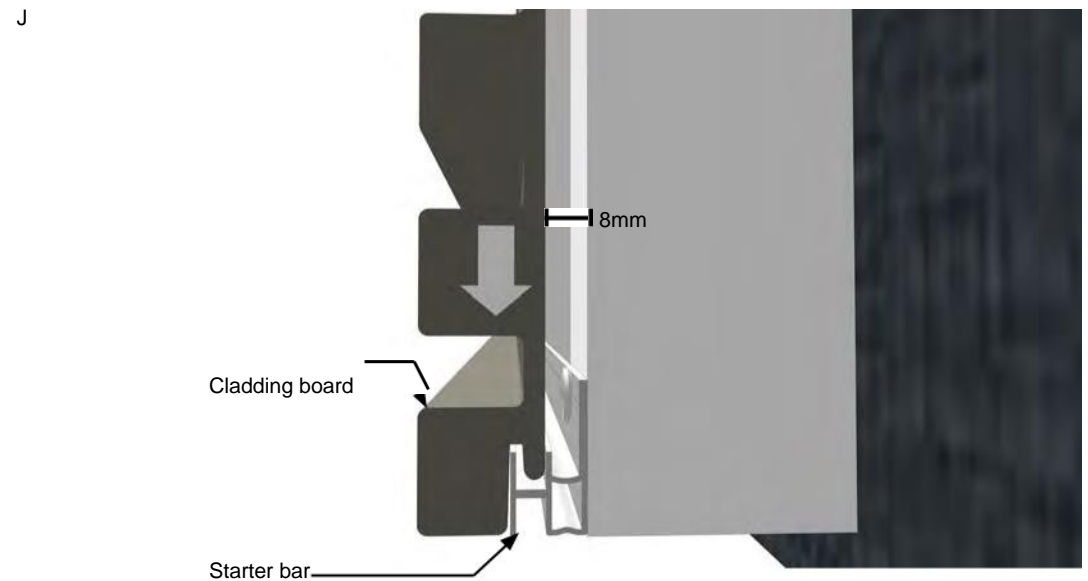

INSTALLATION - FACADE SYSTEM - HORIZONTAL

STEP 6

ENSURE SUFFICIENT GAPS TO END

- K Cladding boards which abut End Trims should be positioned with a 5mm gap between the end of the board and the trim face. Refer to expansion gap table on page 54.

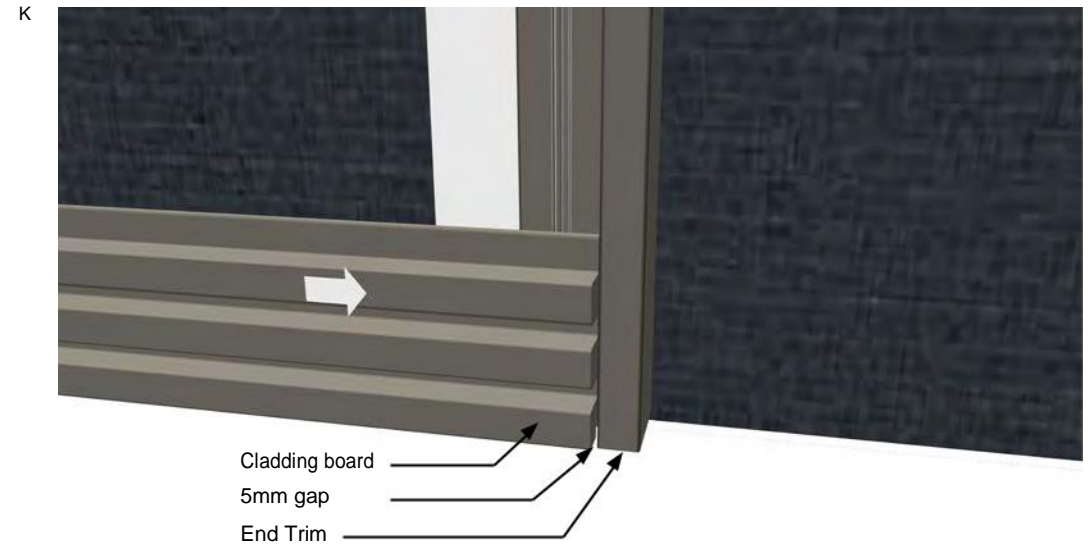

- L Boards which abut a corner trim should be positioned 5-7mm away from the corner trim batten face - as shown in the diagram. This is to allow the board to sit flush against the trims back face, and not ride up on the trims profile.

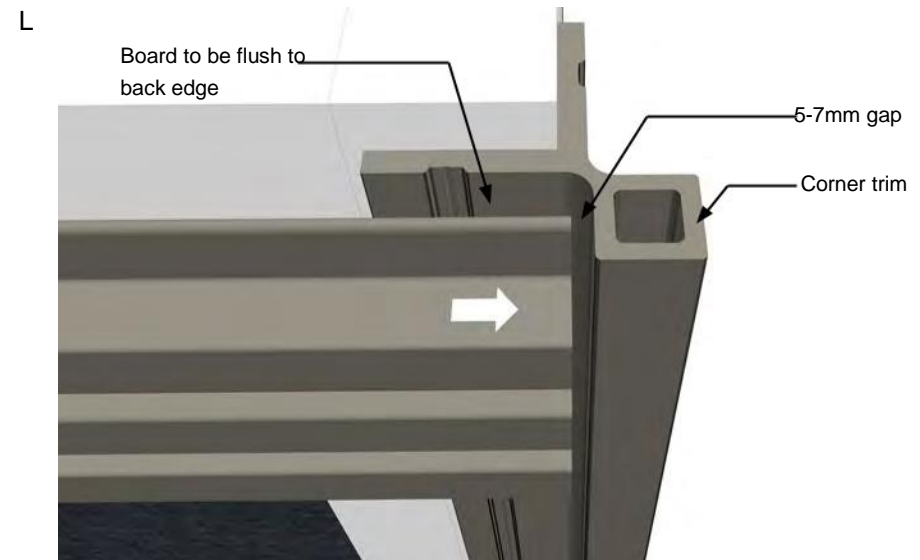

INSTALLATION - FACADE SYSTEM - HORIZONTAL

STEP 7

FIX THE ALUMINIUM CLADDING CLIPS

- M Slide an aluminium cladding clip over the top edge of the cladding board and align it with the centre of the batten.

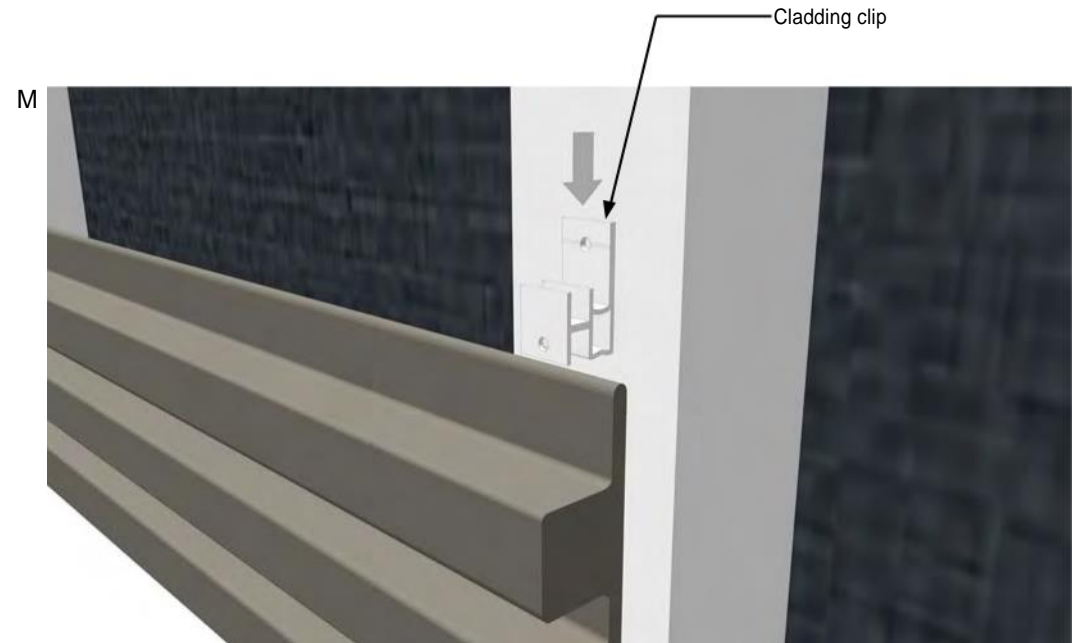

- N Use wood screws (stainless steel wood screws (available from tekBoard)) to fix the clip into the joist.

Note - Do not fix through the clip into the cladding board.

Continue to fix the remaining clips along the rest of the board - every 500mm.

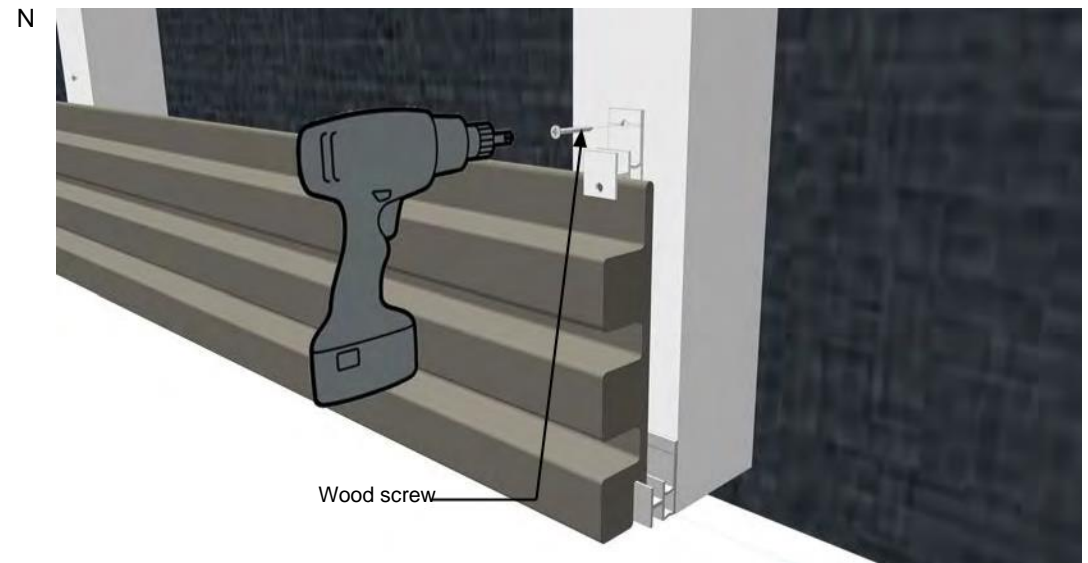

INSTALLATION - FACADE SYSTEM - HORIZONTAL

STEP 8

FIX THE 'LOCKING' CLIP

- O To ensure even expansion and contraction of the boards, and to prevent the boards from moving, you may choose to secure each cladding board using the central cladding clip - ONLY!

Please make sure to pre-drill through the cladding board before fixing the screw to avoid splitting.

- P This will allow for even expansion and contraction along the length of the board, as shown adjacent.

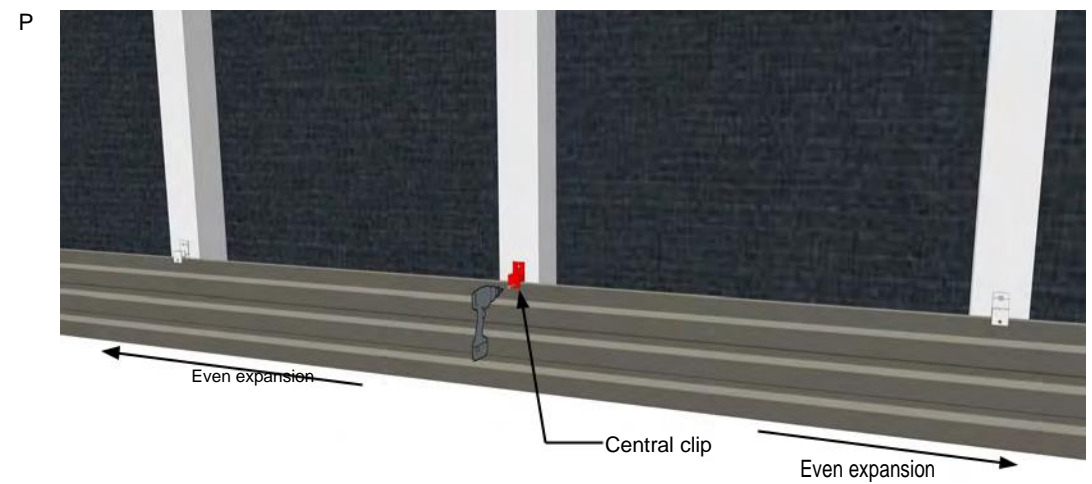
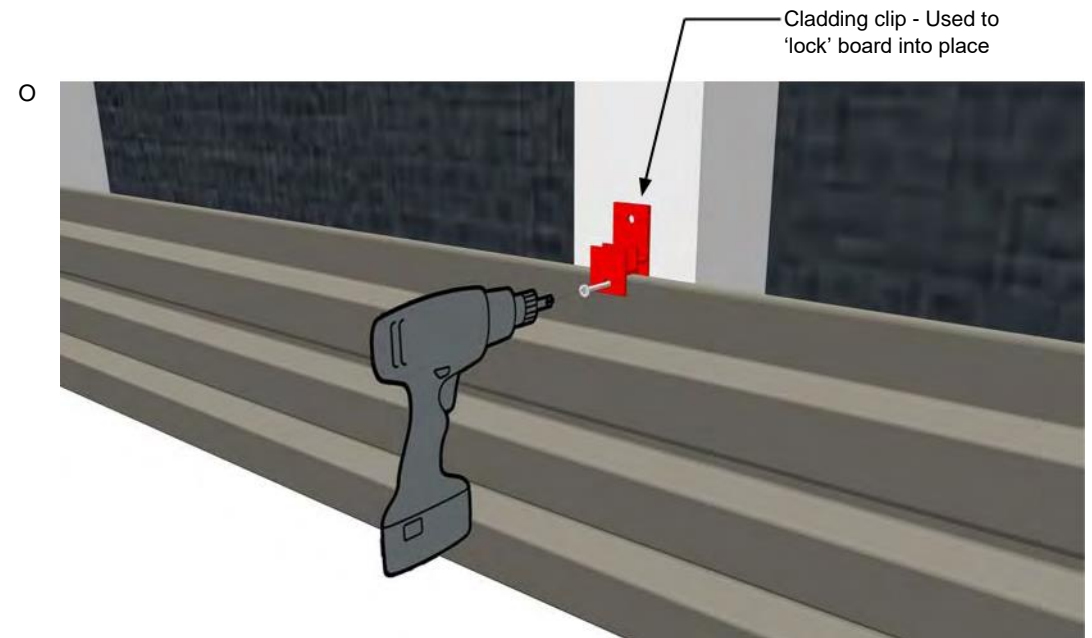

INSTALLATION - FACADE SYSTEM - HORIZONTAL

STEP 9

INSTALL THE SECOND CLADDING BOARD

Q Install the remaining cladding boards in the same way as steps 5 to 8.

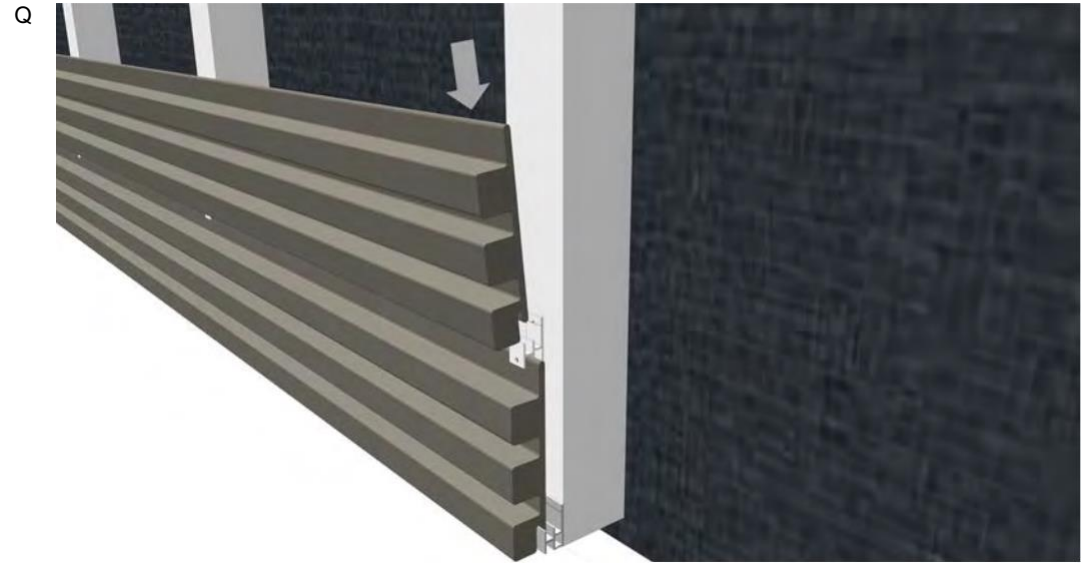

R Where boards meet end to end, ensure the appropriate expansion gap is left between boards. Refer to the table on page 54 for distances.

Double battens should be used no more than 20mm apart to ensure a secure fixing.

Note - Any length of board up to 5400mm is available on request (12 week lead time).

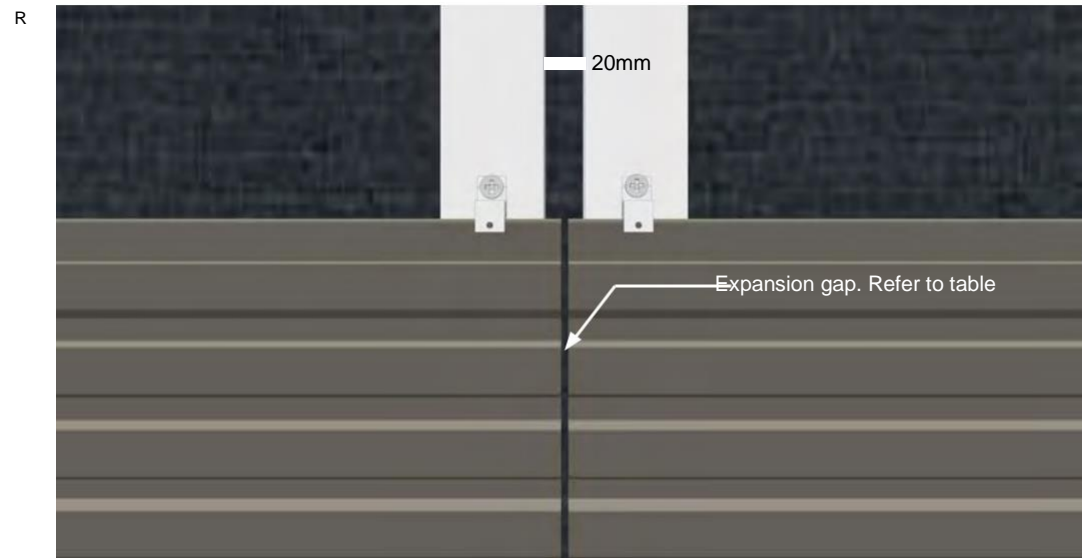

INSTALLATION - FACADE SYSTEM - HORIZONTAL

STEP 10

INSTALL THE SECOND CLADDING BOARD

- S Use our stainless steel colour coded screws to fix the final cladding board through the end trims and into the joists.

Note - On some projects you may not choose to finish with an end trim at the top as shown adjacent. All projects differ and comes down to taste.

Note - Ensure all holes are pre-drilled and countersunk to achieve a smooth finish. We recommend installing through the recess and not the batten part of the cladding.

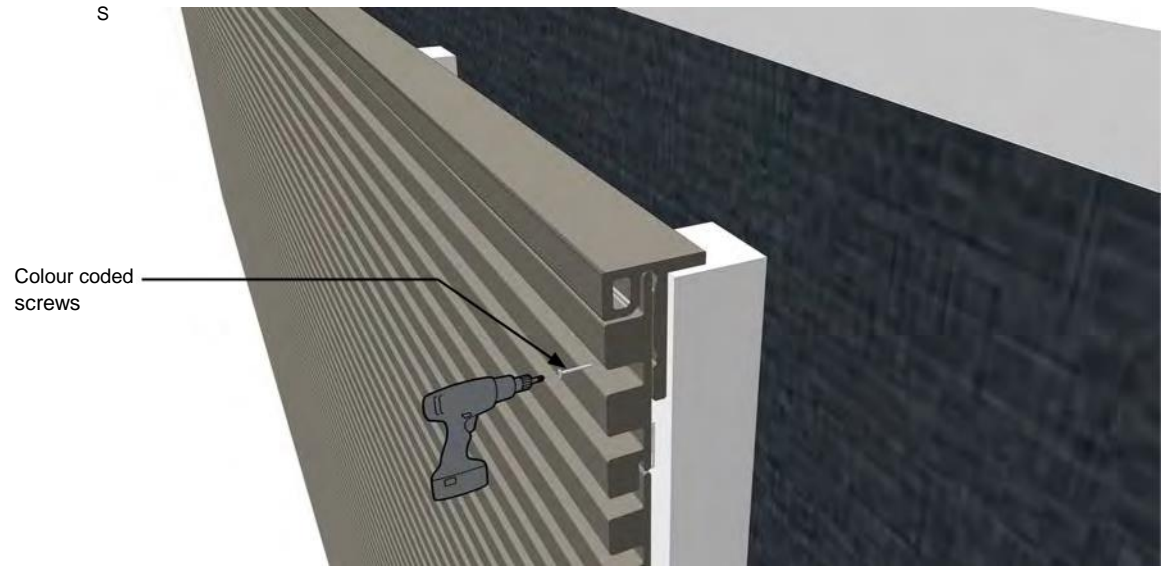

- T Where a final aluminium cladding clip or end trim cannot be used, a plastic pad can be used to fix any end boards as shown adjacent.

Note - Ensure all holes are pre-drilled and countersunk to achieve a smooth finish. We recommend installing through the recess and not the batten part of the cladding.

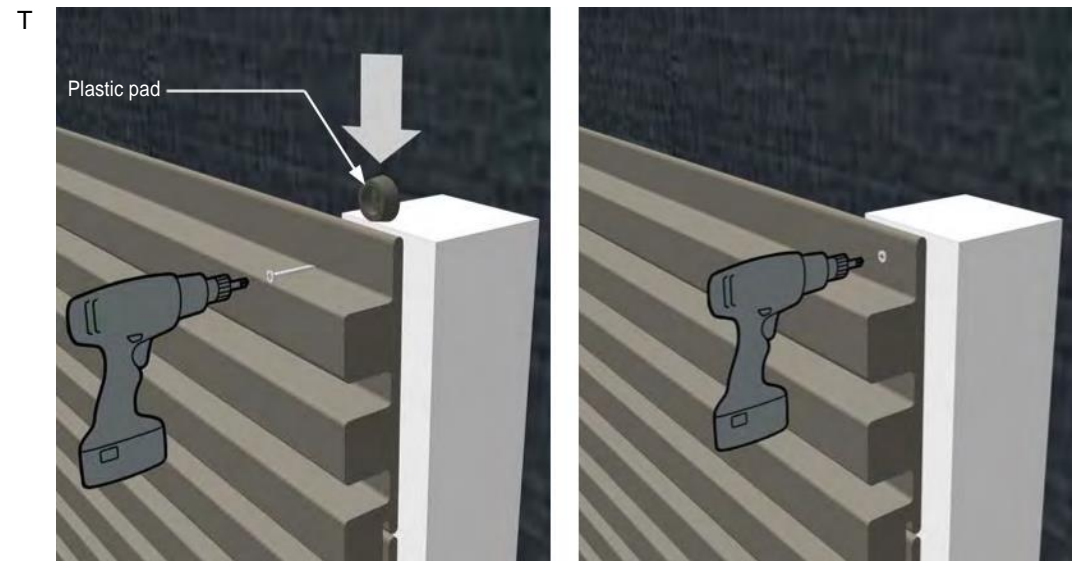

INSTALLATION - FACADE SYSTEM - HORIZONTAL

STEP 11

CORNER AND WALL END DETAILS

- V Corner trims can be used to create a neat finish to corners. Ensure the trims are installed on a full corner sub-frame as shown adjacent.

Ensure a sufficient expansion gap is left between the end of the board and the corner trim profile. Refer to the expansion gap table on page 54 for distances.

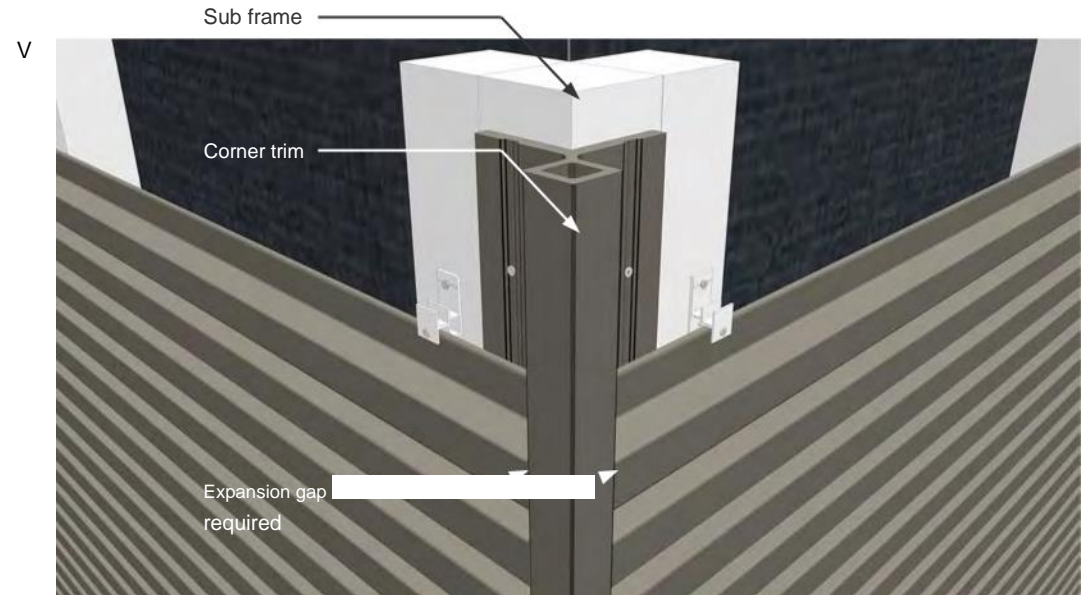

- W Where cladding panels run into a wall or post, an end trim is not always required. Just ensure an expansion gap is left between the end of the board and the face of the wall. Refer to page 54 for distances.



INSTALLATION - FACADE SYSTEM - HORIZONTAL

STEP 12

GARAGE DOORS

- X For garage doors, end trims can be mitre cut to create a neat finish to the door opening. Ensure any panels butting up to the end trim are off set with a sufficient expansion gap.

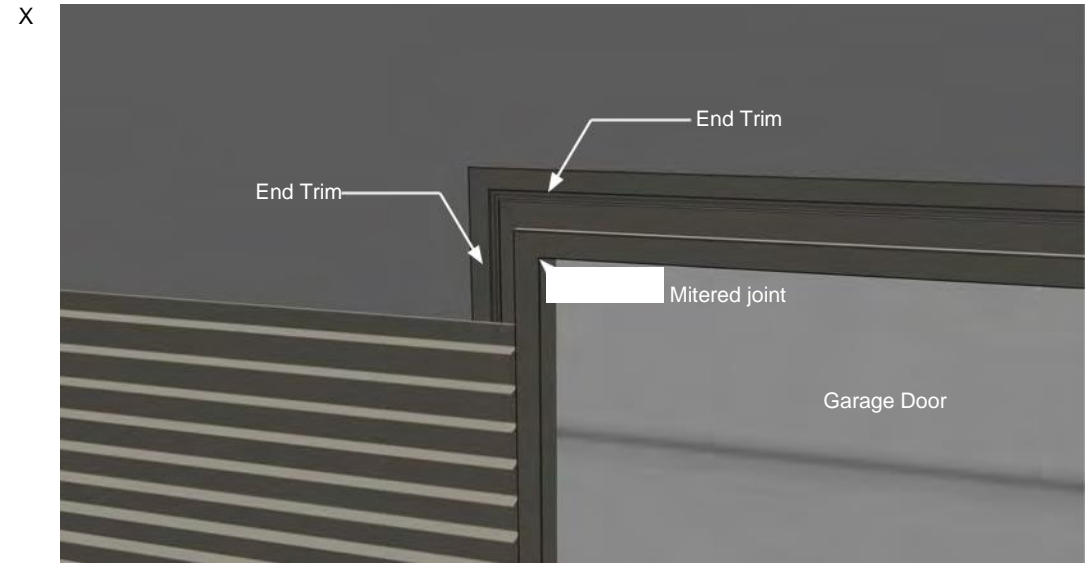

- Y The first panel above the door can be fixed with a colour coded screw as a cladding clip cannot be fixed in place - unless recesses are cut out of the end trim to make room.

Ensure all holes are pre-drilled and countersunk.

Note - Cladding boards can also be cut along their length however this is best done along any recesses for best durability and aesthetics.

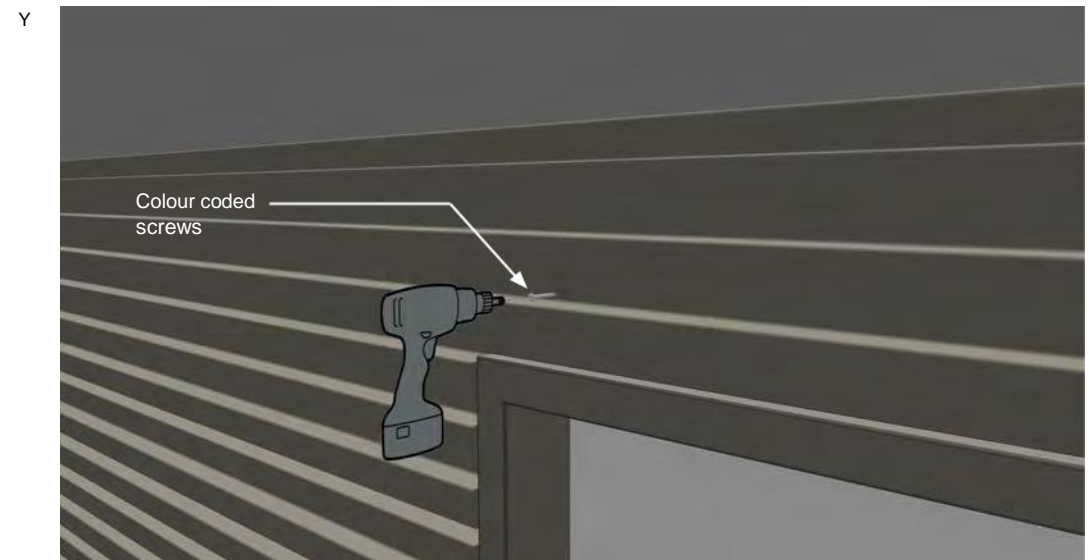

INSTALLATION - FACADE SYSTEM - HORIZONTAL

STEP 13

WINDOW DETAILS - SHALLOW RECESS

Z Details around windows can be achieved using either the corner or end trims. For shallow recessed windows use an end trim, mitered at the corners to create a picture frame around the window.

As always, ensure that holes are pre drilled and counter sunk.

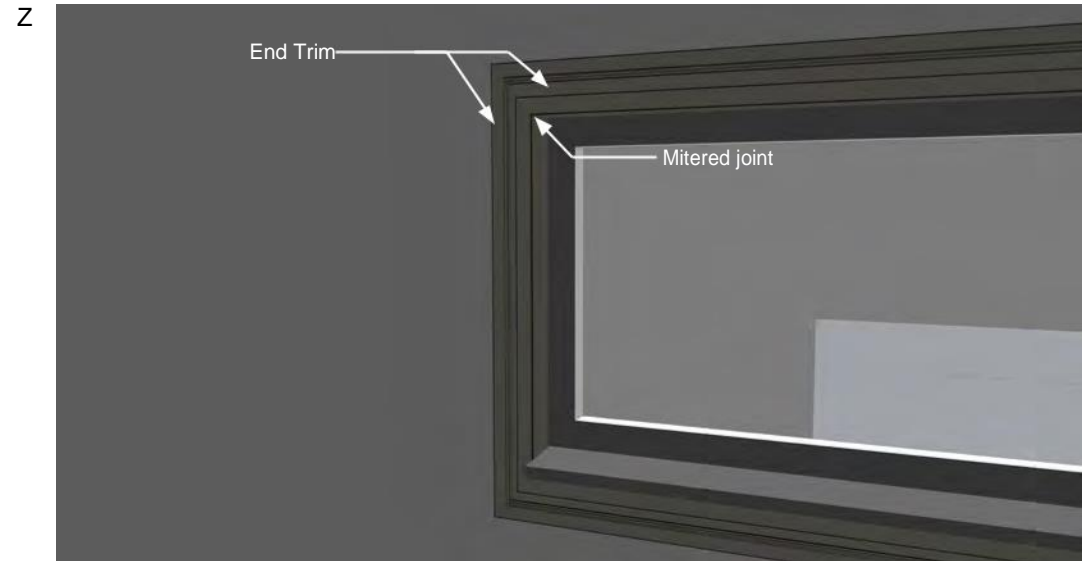

A1 Cladding can then be laid around the window and the joints around the frame sealed with colour matching mastic to achieve a neat finish.

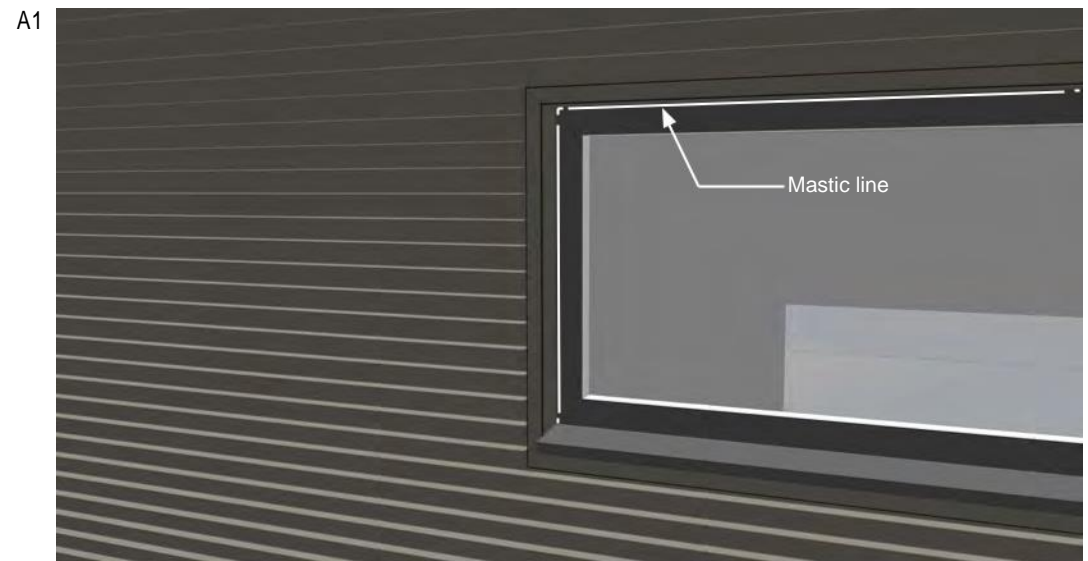

INSTALLATION - FACADE SYSTEM - HORIZONTAL

STEP 14

WINDOW DETAILS - DEEP RECESS

B1 For windows with a deeper recess, a corner trim can be used to return the cladding into the recess. The cladding can then abut the window frame directly, or an end trim can complete the cladding.

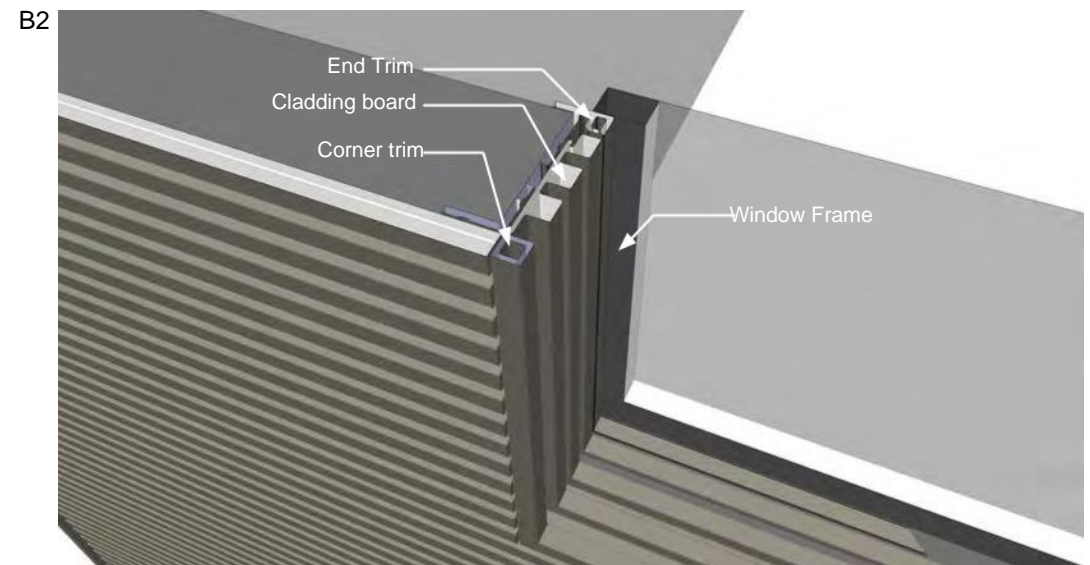
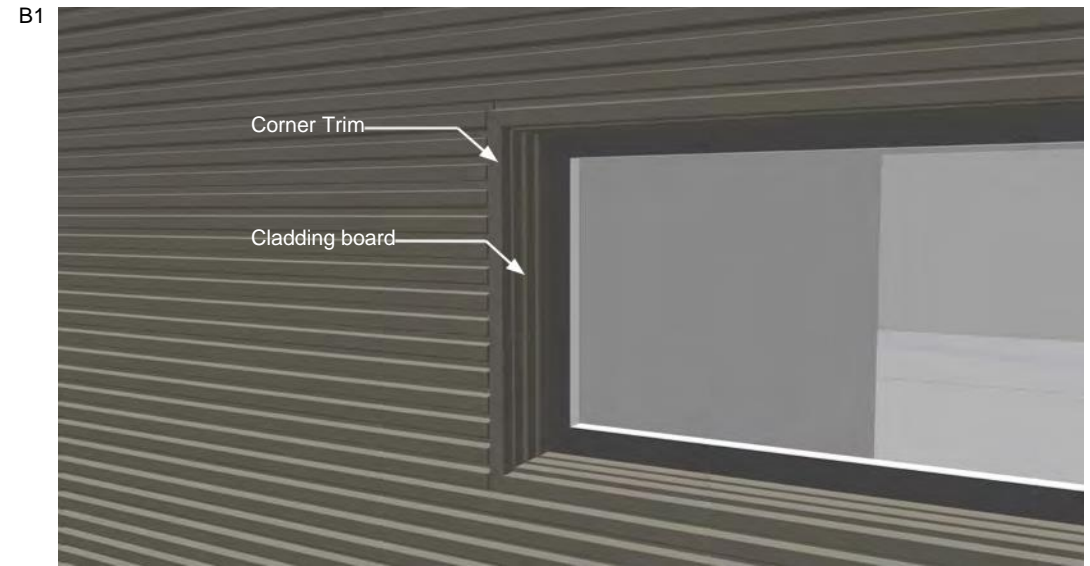

INSTALLATION - FACADE SYSTEM - HORIZONTAL

STEP 15

FINALISE THE FACADE

C1 Complete the remaining sections of the facade in the same manner.

Job done!

C1

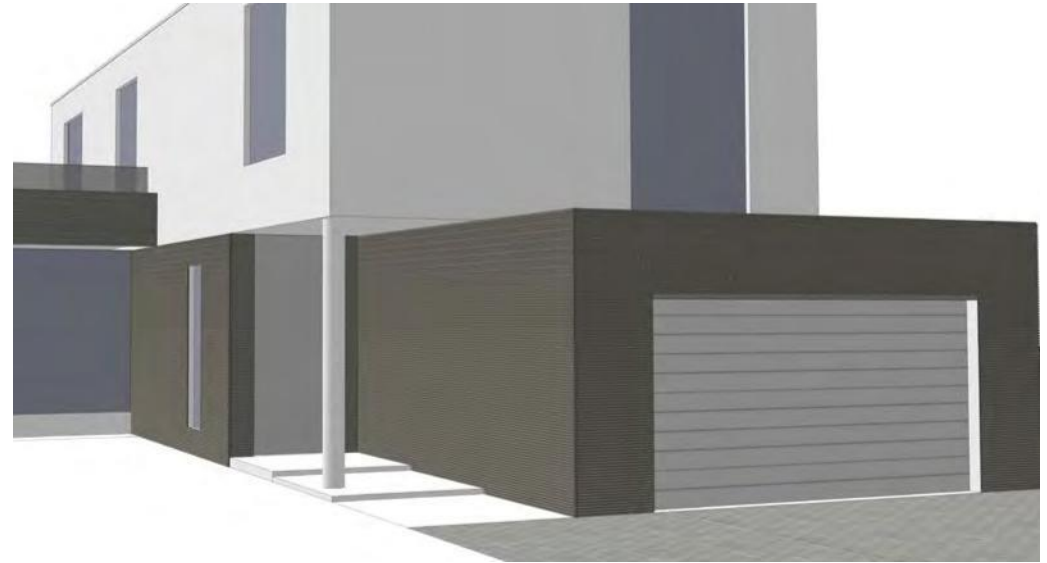

INSTALLATION - FACADE SYSTEM - VERTICAL

STEP 1

INSTALL THE JOISTS AND TRIMS

- A An alternate method is to install the cladding panels vertically. For this the sub-frame joists will need to run horizontally to the ground.

As with the vertical method, the joists should be secured appropriately, onto a suitable wall with vapor membrane or similar in place.

Ensure that the joists are level and spaced at 500mm centers.

A double row should be installed in the centre with the joists 50mm apart. This is for the locking clips which will be installed later.

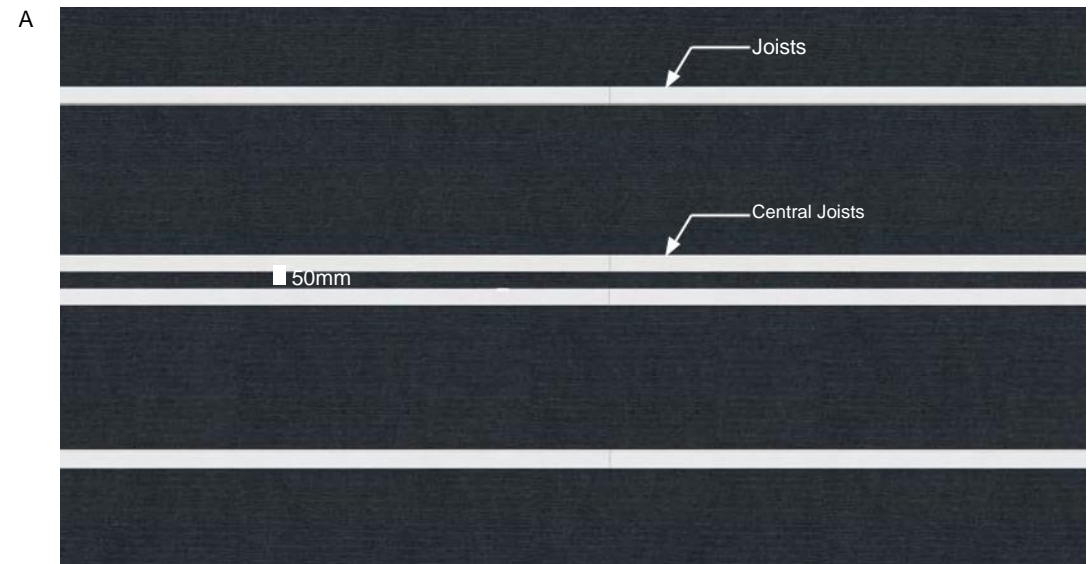

- B As with the horizontal method, install the corner and end trims first.

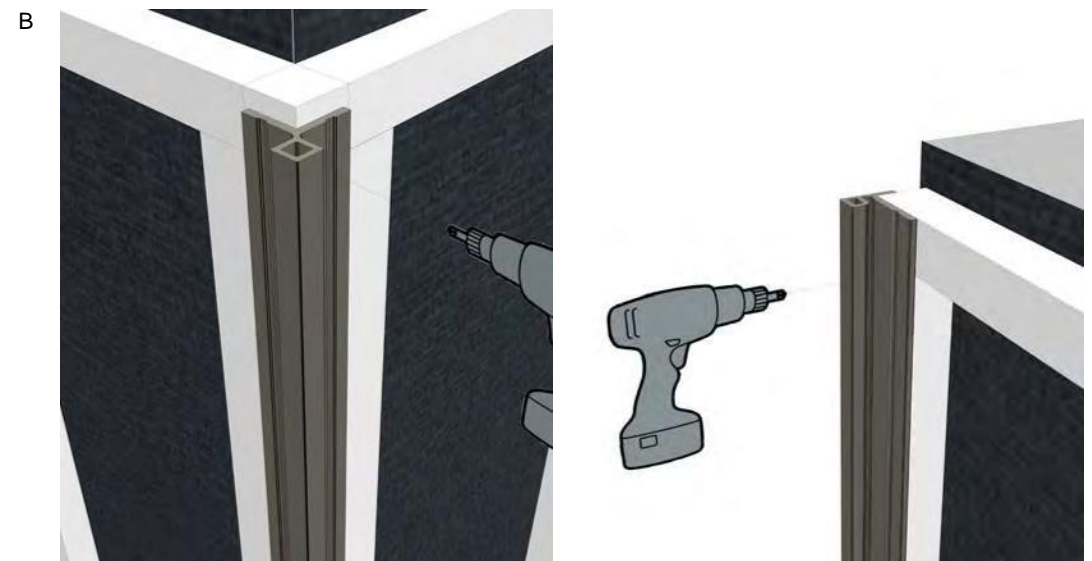

INSTALLATION - FACADE SYSTEM - VERTICAL

STEP 2

INSTALL THE BASE TRIM

- C When laying the boards vertically it is best practice to run an end trim horizontally across the bottom of the boards. This hides the hollow section of the cladding board, and finishes it off well. On some projects this may not be needed if the cladding is sitting on brick/aluminium detail, or sufficiently low enough that the bottom of the boards will not be seen.

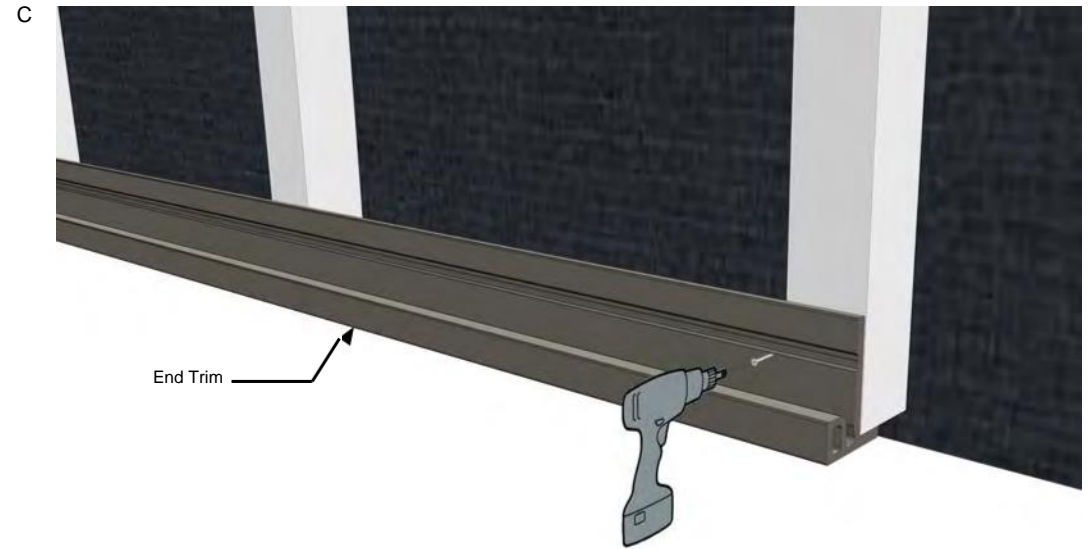

- D Cladding boards will need to be packed up above the end trim to create an expansion gap. Refer to the table on page 54 for the distances required.

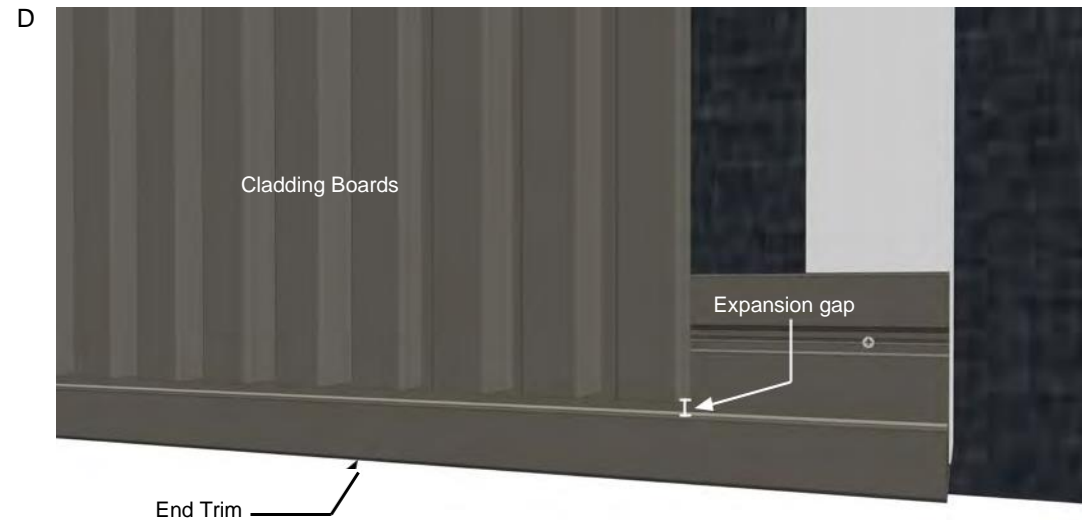

INSTALLATION - FACADE SYSTEM - VERTICAL

STEP 3

START INSTALLING THE CLADDING BOARDS

E If you start installing the vertical cladding in a corner where no trim is needed then the first board can be installed with a starter bar as shown adjacent.

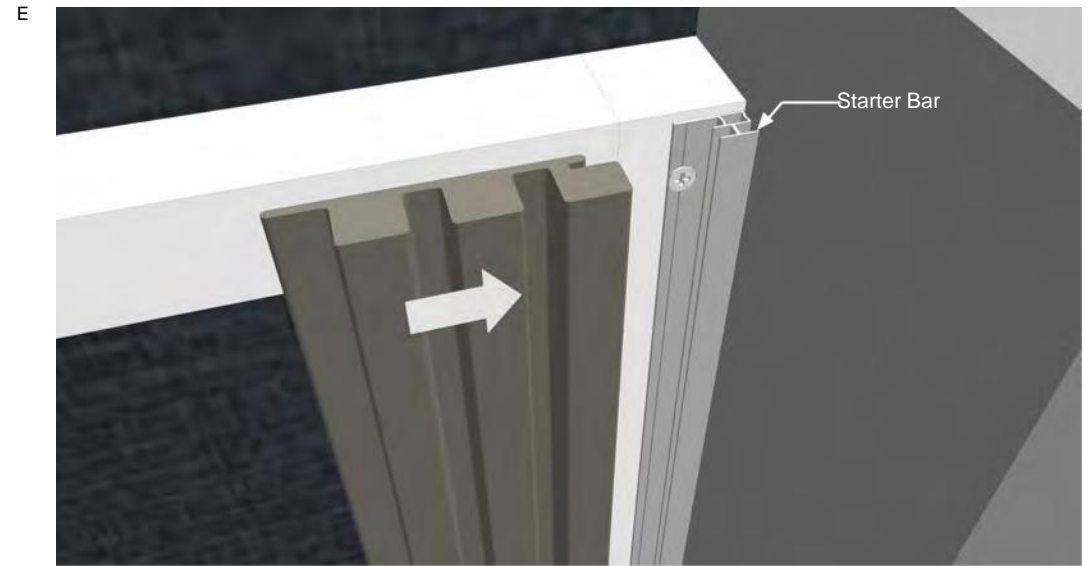

F If you need to use an end trim or corner trim to start then you will need to face fix the first board using stainless steel powder coated screws. Ensure you fix in the recess of the board and pre drill and countersink for a flush finish.

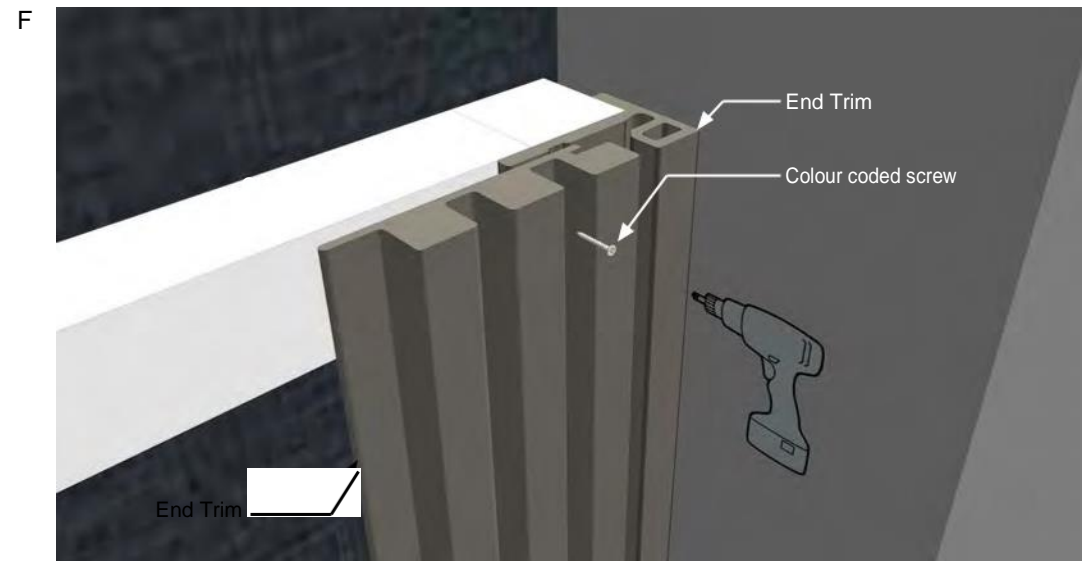

INSTALLATION - FACADE SYSTEM - VERTICAL

STEP 4

INSTALL THE CLADDING BOARDS

- G Fix the first cladding board to the joists, using the supplied clips. Ensure that the board is vertical, and pushed into the first stop or corner trim.

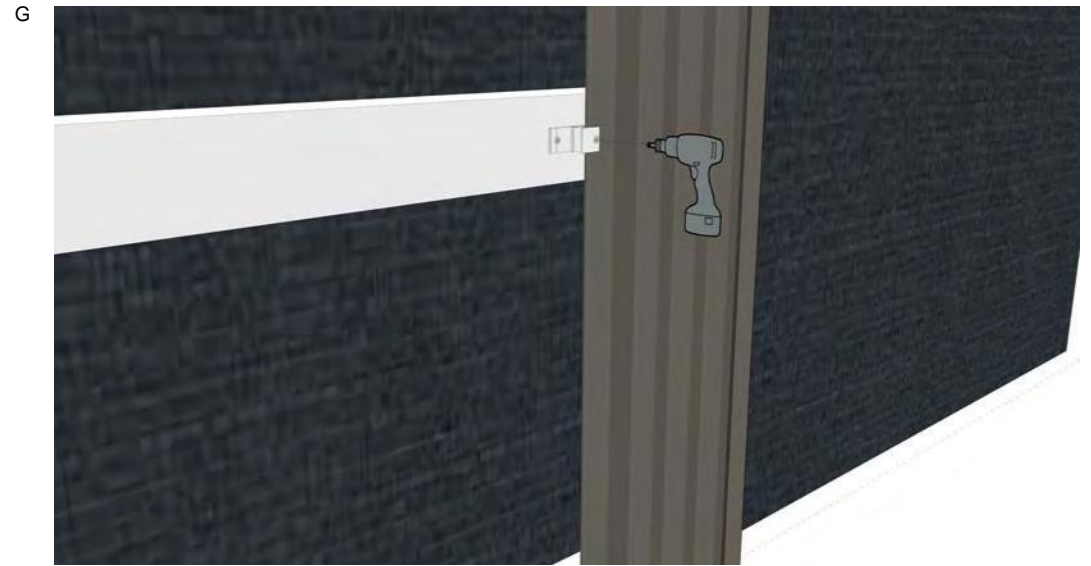

- H Boards should be 'locked' in place with the two central clips to ensure they do not fall. These should be installed on the two central joists which are 50mm apart. Ensure to pre drill through the cladding prior to fixing.

Install the remaining boards in the same way

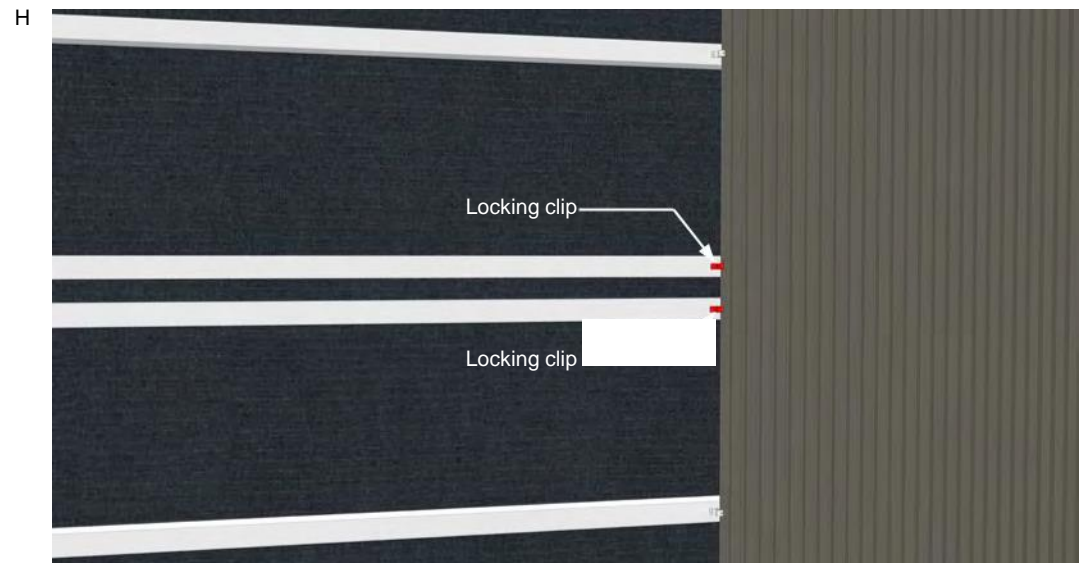

INSTALLATION - FACADE SYSTEM - VERTICAL

STEP 5

INSTALL THE FINAL BOARDS

- I The final cladding board can be slotted into place and fixed with a colour coded screw through the stop or corner trim. Ensure the holes are pre-drilled and countersunk for a neat finish.

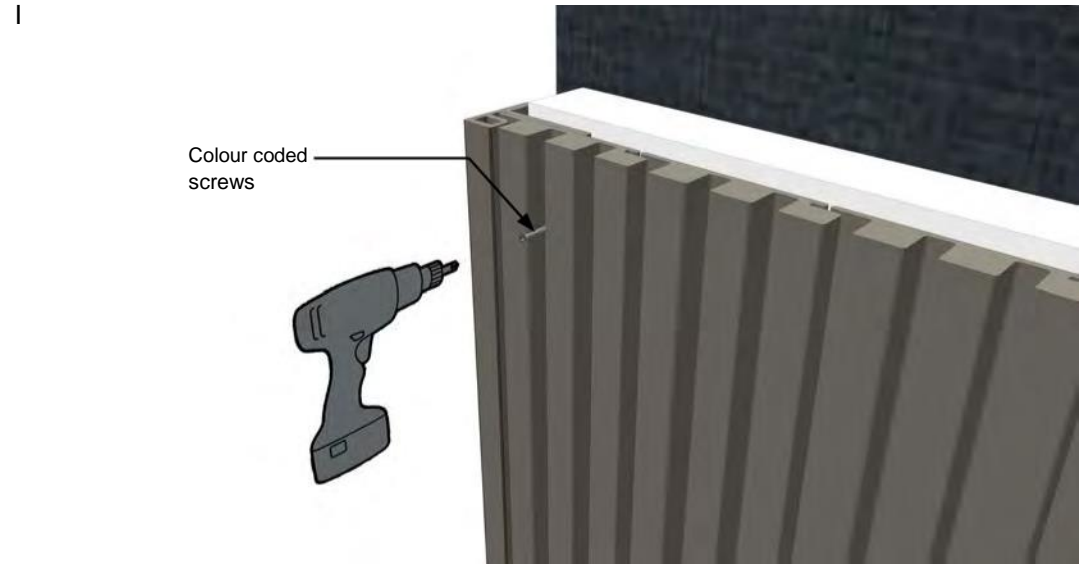

- J Complete the remaining sections of the facade.
Job done!



INSTALLATION - FACADE SYSTEM - SOFFIT

STEP 1

INSTALL THE SOLID PLASTIC JOISTS

A There are multiple ways to construct a soffit whilst using the slatted cladding system. The next few pages show a typical scenario, however other methods can be used.

Use treated timber joists to wrap the underside and front face of the soffit. Fix them appropriately at 500mm centres.

Note - Solid plastic and aluminium joists are also available from tekBoard.

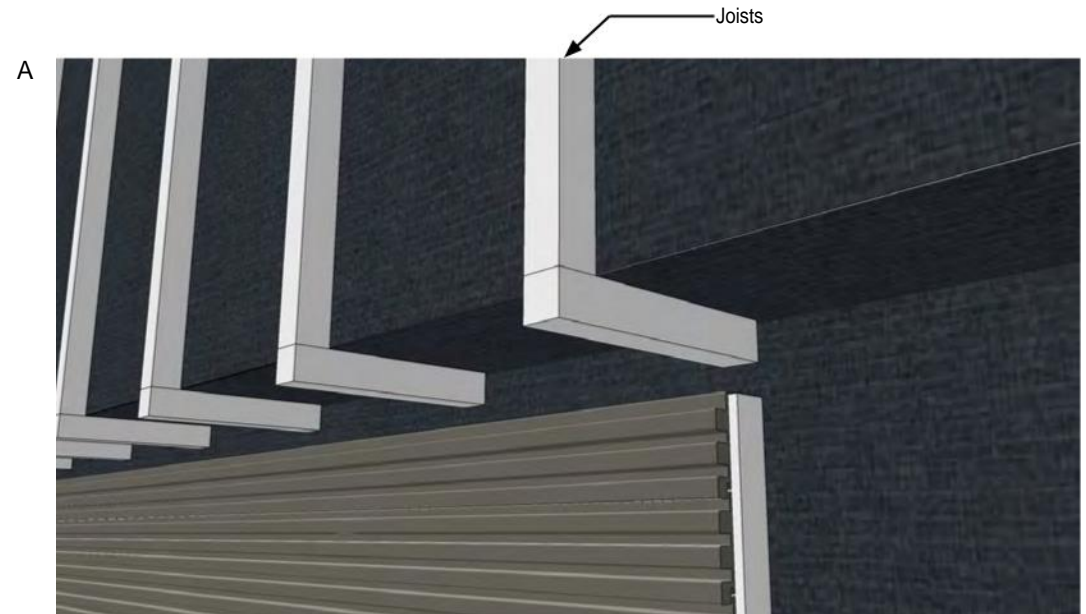

B Depending on the height of the soffit you can either;

- Clad up to the underside using the cladding panels and finish with an end trim, or;

- Clad up to the underside and use the plastic pads and colour coded screws to fix the last board.

Either method can work depending on the scenario.

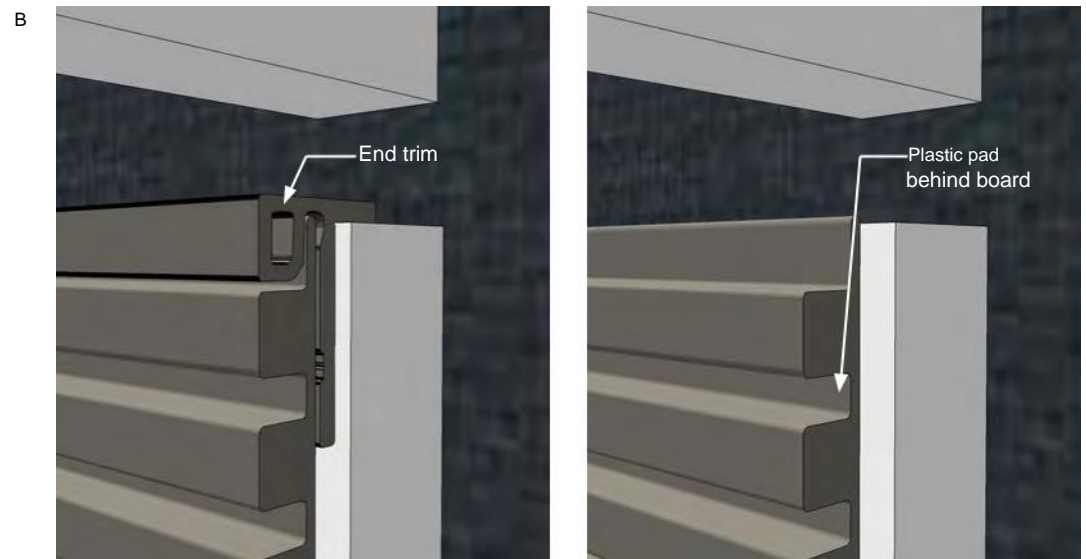

INSTALLATION - FACADE SYSTEM - SOFFIT

STEP 2

INSTALL THE SOFFIT

- C Fix the corner trim to the edge of the joists using the supplied wood screws. Ensure screws are pre drilled and counter sunk.

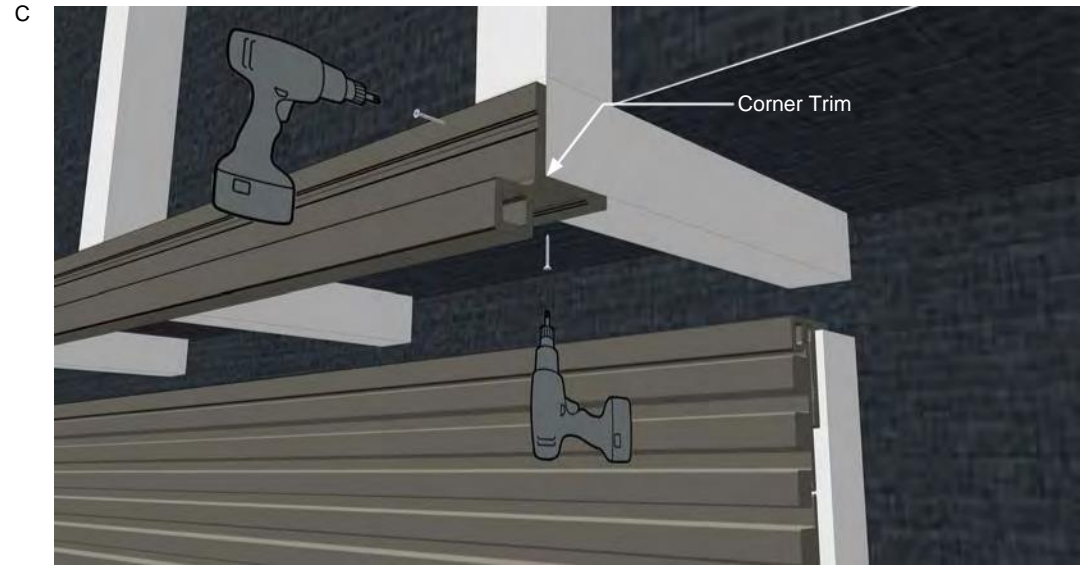

- D Measure and install the cladding clips and boards as required.

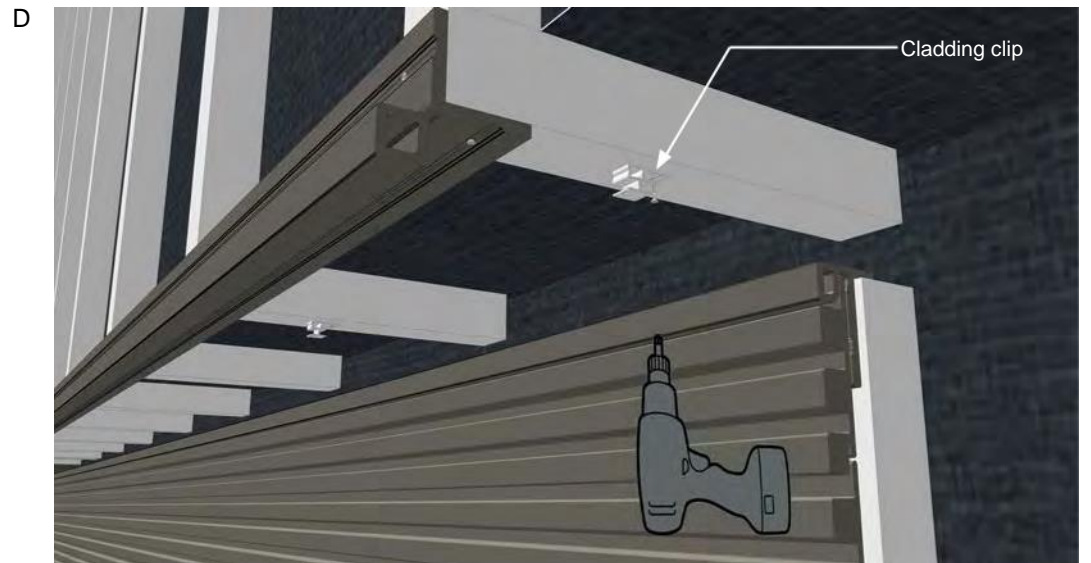

INSTALLATION - FACADE SYSTEM - SOFFIT

STEP 2 - CONT.

INSTALL THE SOFFIT

- E Any boards fixed through the face must be pre drilled and screws counter sunk for a flush finish.



INSTALLATION - FACADE SYSTEM - SOFFIT

STEP 3

FIX THE OUTER FACADE

- F Next, fix the first board to the outside face. Ensure a suitable even gap is left to the corner trim. Ensure to pack the cladding board up to leave an expansion gap - refer to the expansion gap table on page 54. Fix the board using colour coded screws - countersunk.

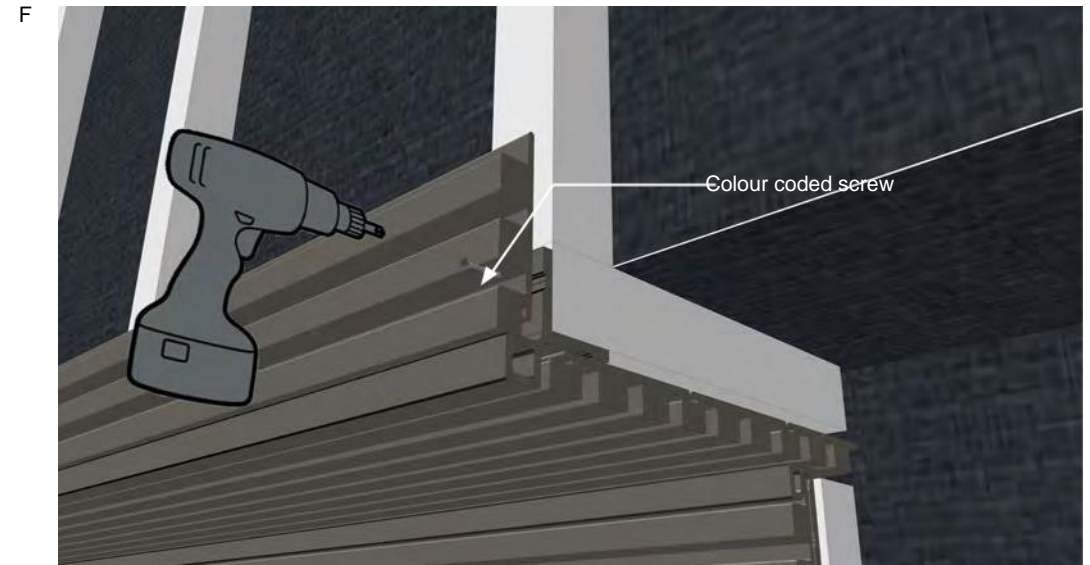

- G Now install the rest of the cladding boards as outlined previously.



INSTALLATION - FACADE SYSTEM - GABLE END

STEP 1

INSTALL THE CLADDING BOARDS

- A Gable end details can also be achieved by fixing the boards and using a cover trim to finish the facade.

Overhang the ends of the boards and fix the boards using the cladding clips.

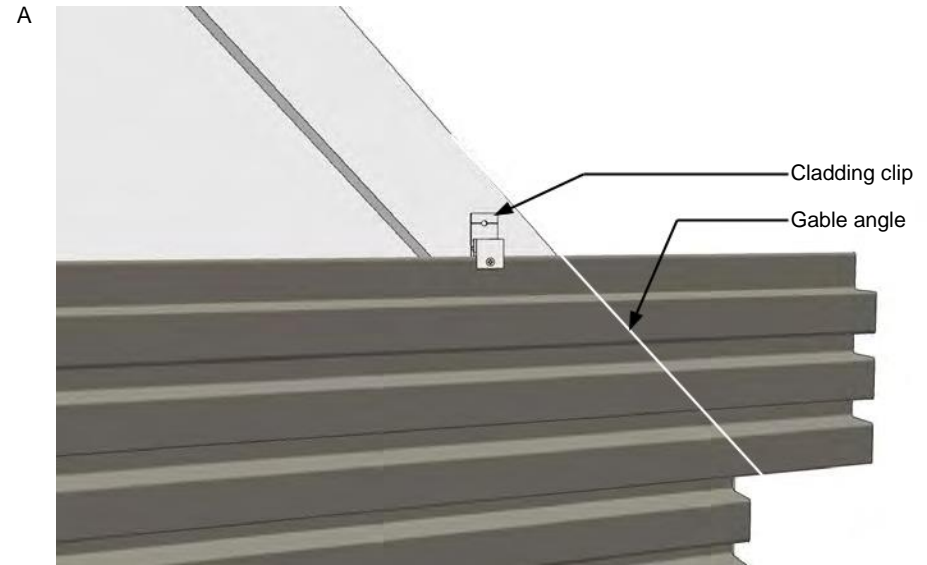

- B The boards can be cut down to align with the angle of the gable.

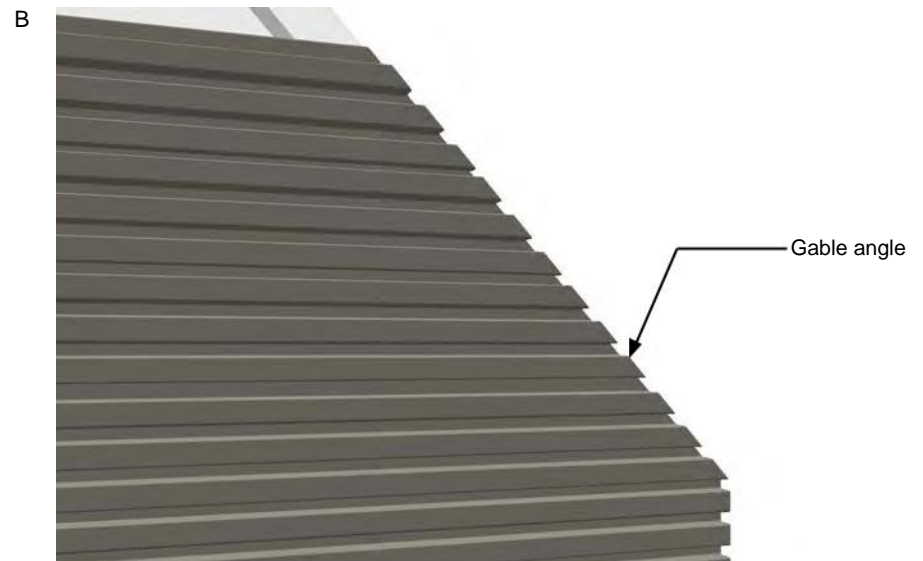

INSTALLATION - FACADE SYSTEM - GABLE END

STEP 2

FINISHING THE GABLE END

- C The final cladding board piece can be cut down to size and fixed using the plastic pad and colour coded screw.

Ensure you pre drill and countersink for best results.

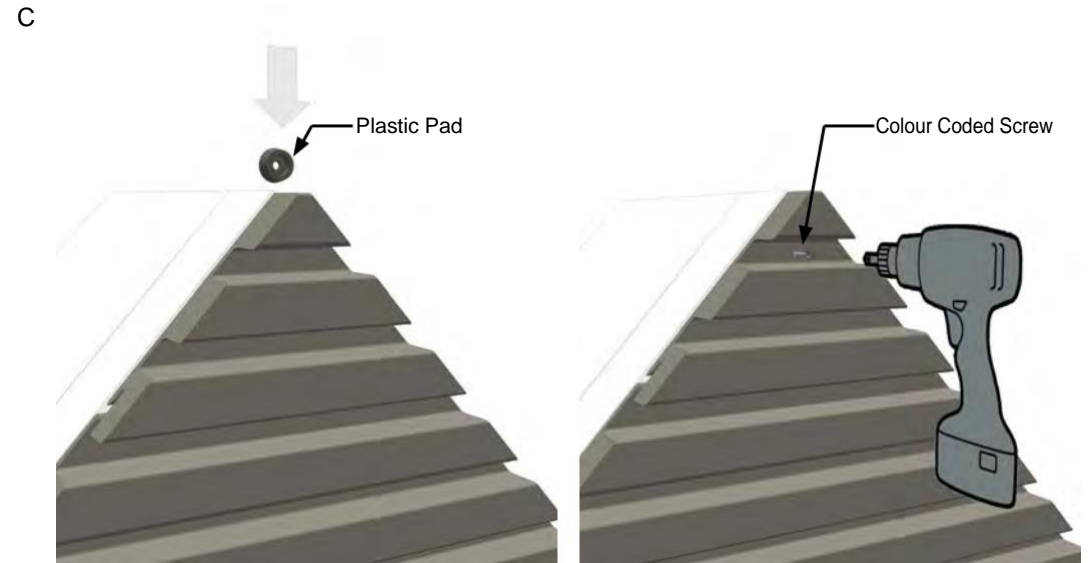

- D A cover trim or similar can then be fixed through the cladding boards to complete the facade profile.

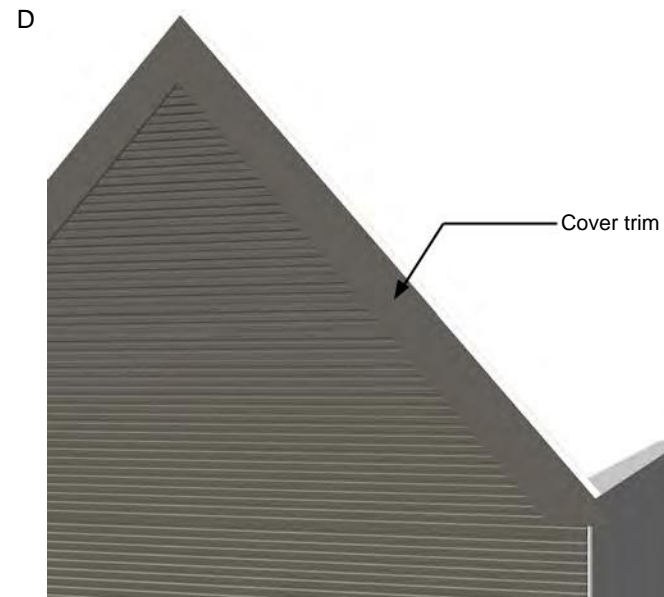

INSTALLATION - FACADE SYSTEM - GABLE END

STEP 3

FINISHING THE GABLE END - ALTERNATE

E Alternatively the gable end can be installed with an End Trim to the outside edge of the boards - similar to the cladding process on page 21.

Ensure you leave a gap for expansion - refer to table on page 54.

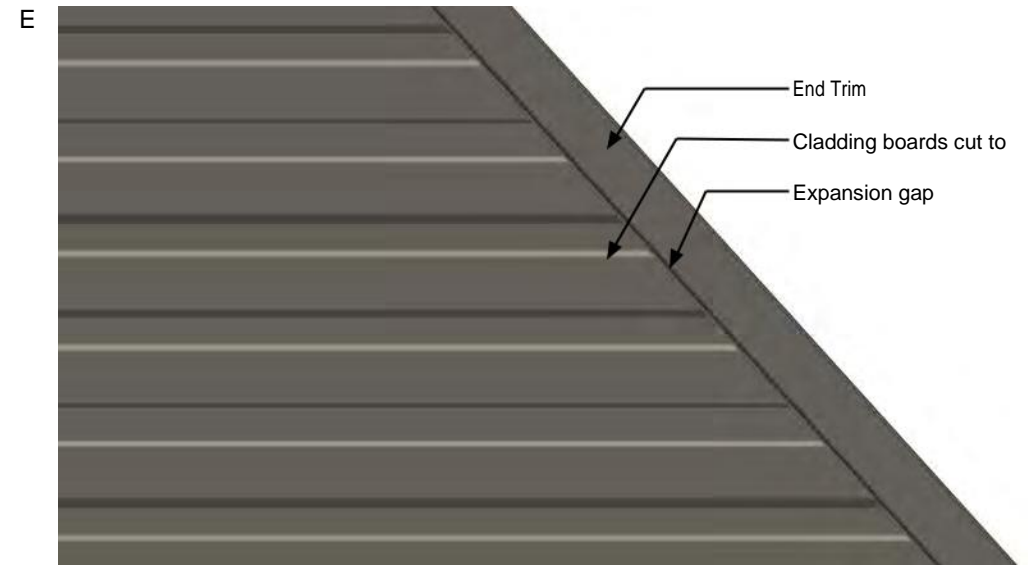

F The End Trims can be mitered to produce a neat finish.

Details around roofs should be considered carefully. Ensure guidance is sought from a professional if you are unsure.

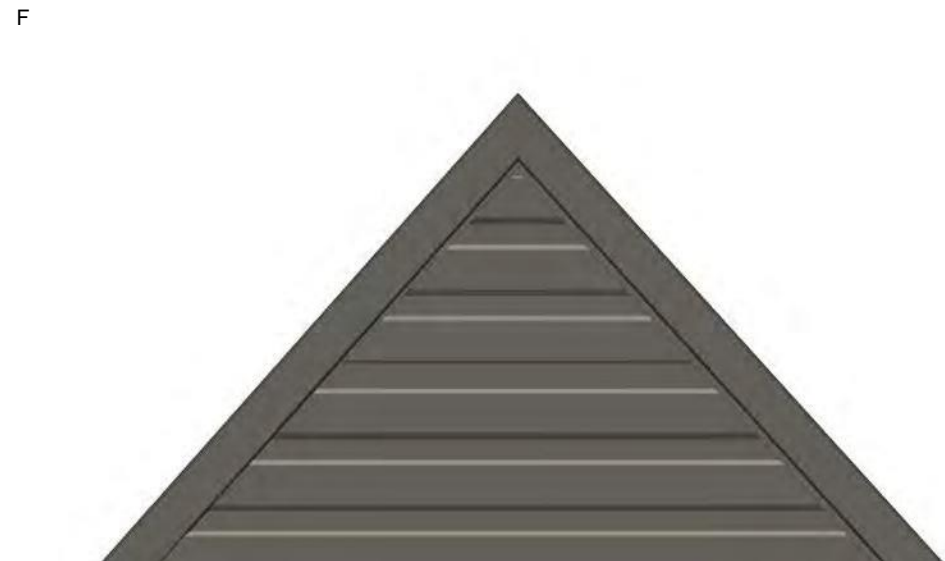

INSTALLATION - FACADE SYSTEM - SECRET DOOR

OVERVIEW

BUILDING A SECRET DOOR

- Slatted cladding can be used to create a wide variety of architectural features, such as secret doors to outdoor rooms!

These can give a professional modernist look but require some careful planning and consideration. Ask an tekBoard member of staff for help if unsure.

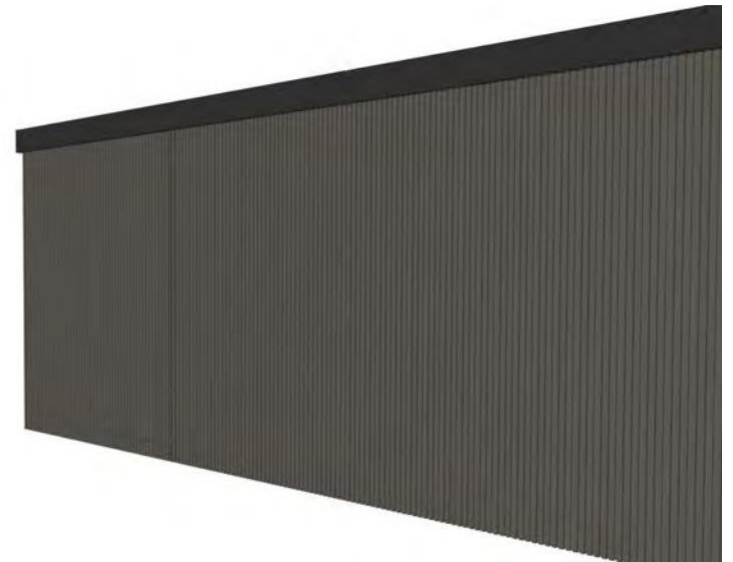
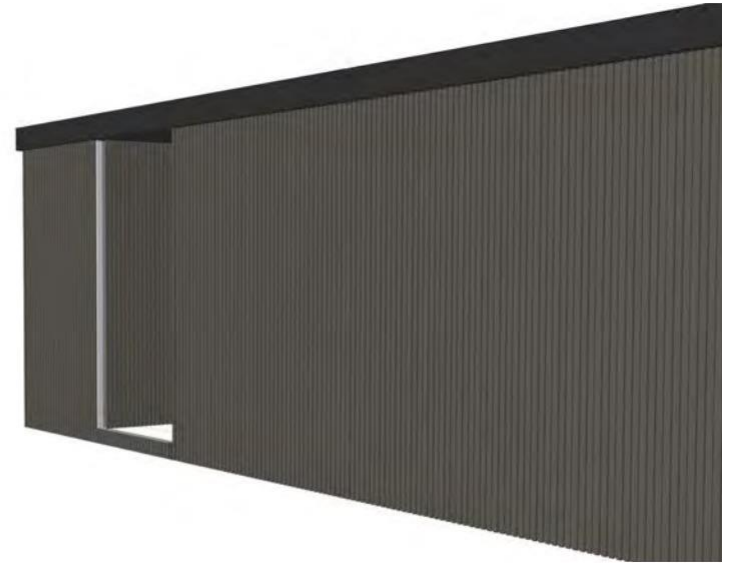

INSTALLATION - FACADE SYSTEM - SECRET DOOR

STEP 1

CALCULATE THE DOOR WIDTH AND INSTALL THE FRAME

- A Door width requirements will vary and our slatted cladding can be cut to fit any size. However where possible its best to size the door to avoid cutting and tie into the rows of cladding boards and trims.

Where possible, we recommend you measure and plan the door frame width prior to construction.

Note - Doors must be hinged from the inside.

A



- B Erect the door frame using treated timber battens. Ensure hinges are positioned to allow for seamless opening. Also consider any weather proofing requirements (seals and sill details) required to keep water out.

Note - Both solid plastic and aluminium joists are also available from tekBoard.

B

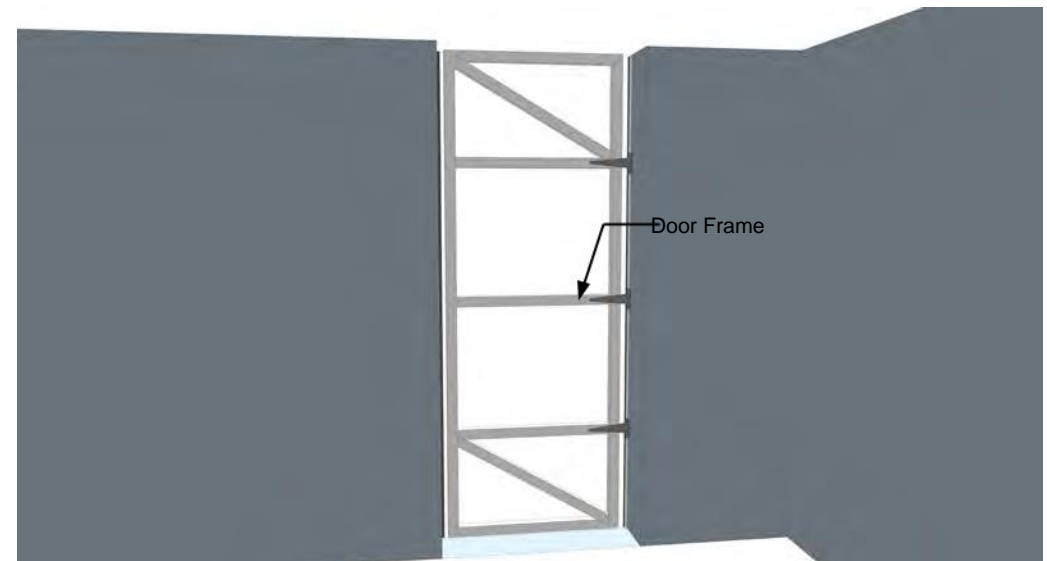

INSTALLATION - FACADE SYSTEM - SECRET DOOR

STEP 2

INSTALL THE TRIMS OR END BOARDS

- C End trims should be installed to the edges of door frames to create a clean edge.

When fixing the final cladding board to the end trims, don't forget to pre drill and countersink the colour coded screws.

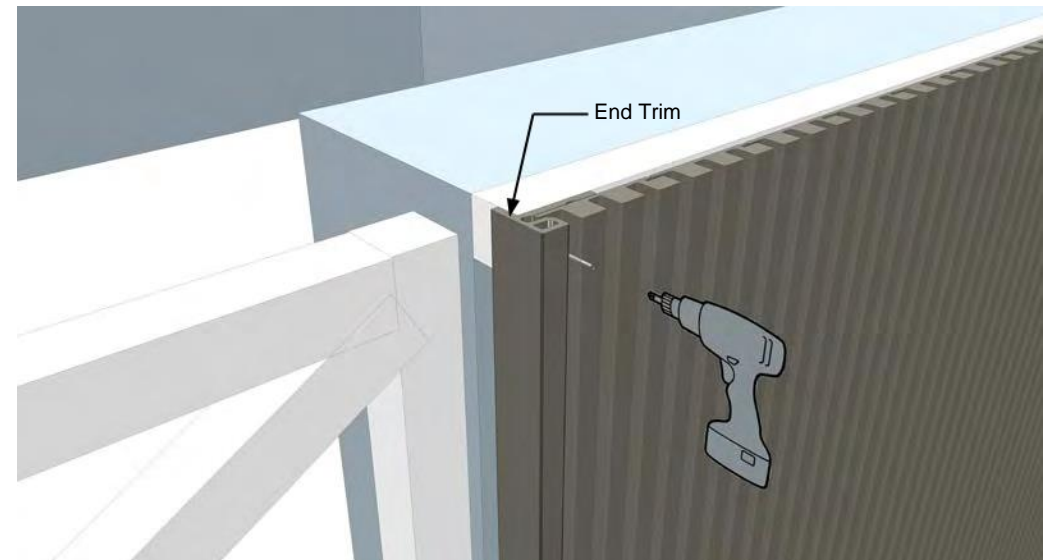
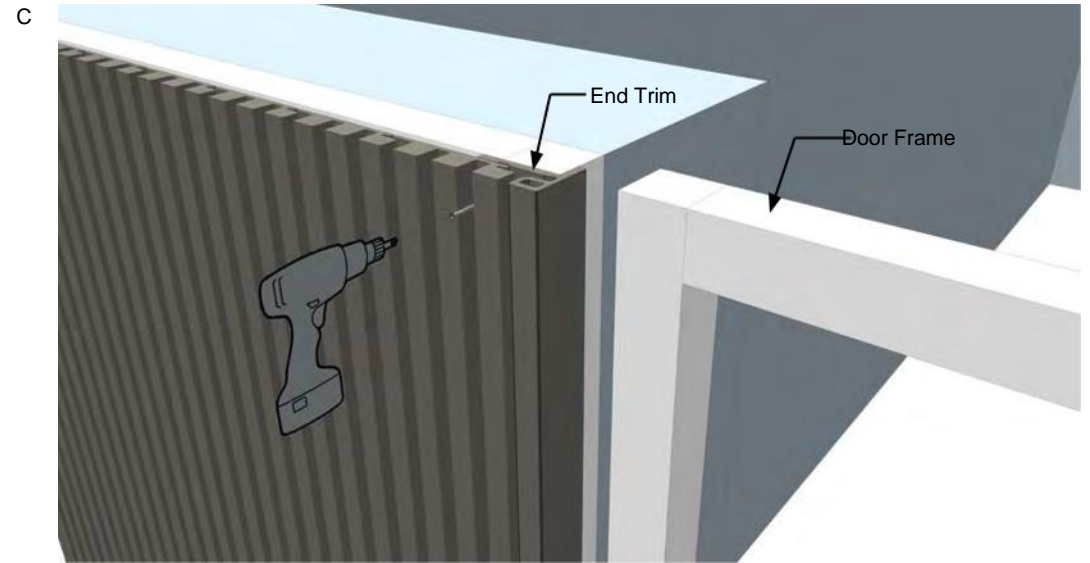

INSTALLATION - FACADE SYSTEM - SECRET DOOR

STEP 3

INSTALL THE CLADDING BOARDS TO THE DOOR

- D Install the cladding boards to the door skeleton. Take care to ensure the gap of the panels is consistent and evenly spaced to ensure a 'hidden' look is achieved.

Boards can be fixed to the door frame using cladding clips.

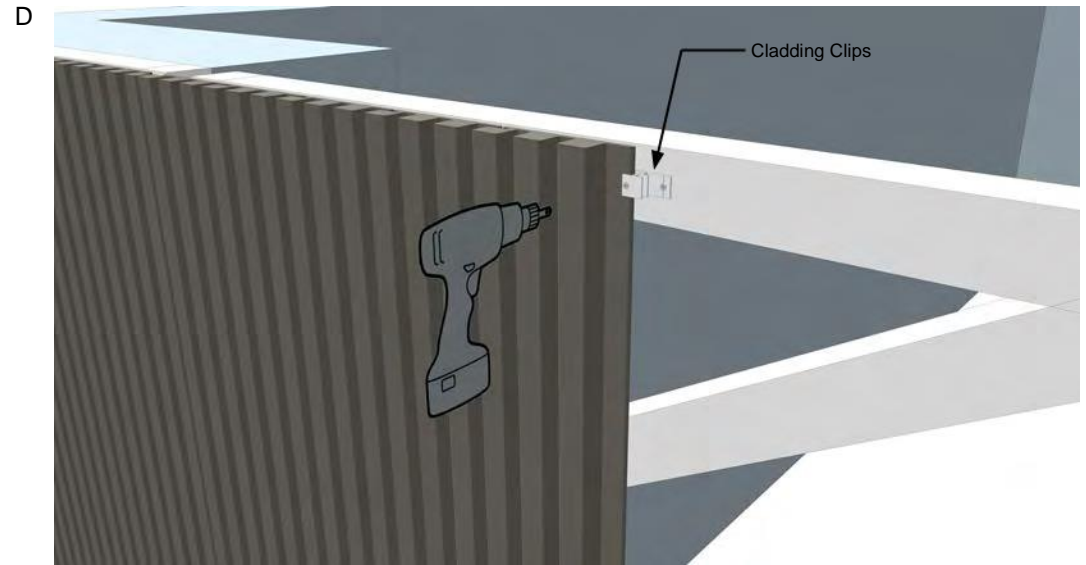

- E Align any base or top facade panels with the door cladding to create a seamless look.

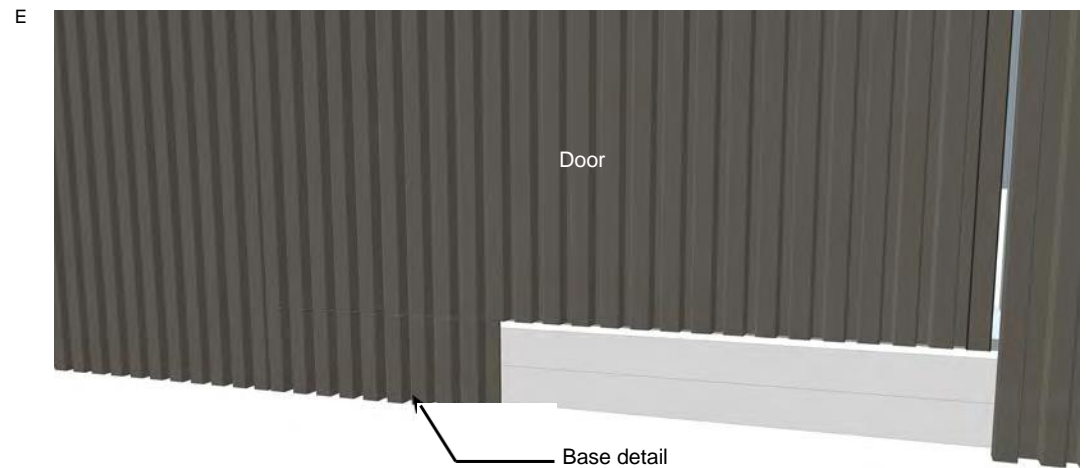

INSTALLATION - FACADE SYSTEM - SECRET DOOR

STEP 4

ADD ANY FINAL TOUCHES

- F Hidden door handles can be routed into the cladding panel to assist with opening and closing the door.

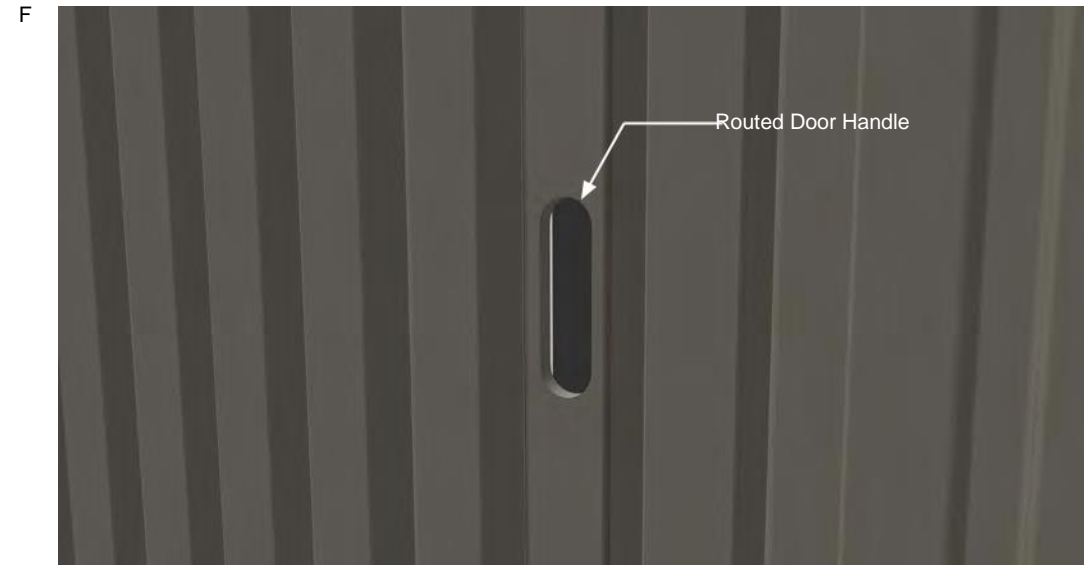

- G Job done!



INSTALLATION - FACADE SYSTEM - ROOF OVERVIEW

CLADDING A ROOF

A Our Slatted Cladding can also be used to clad roofs!

Building designs vary widely and our Slatted Cladding can be used to suit many designs. It's important to note however that roofs are a critical Architectural detail and tekBoard cannot take any liability for poorly designed and constructed roof profiles. If unsure seek professional help or ask a tekBoard member of staff.

Much of the installation follows the principles outlined previously in this manual. The following pages show how the cladding may interface with a typical box gutter detail.

B The adjacent section shows a typical box gutter type detail. A wide variety of gutter interfaces are possible and we recommend seeking the advice of a professional if unsure.

A



B

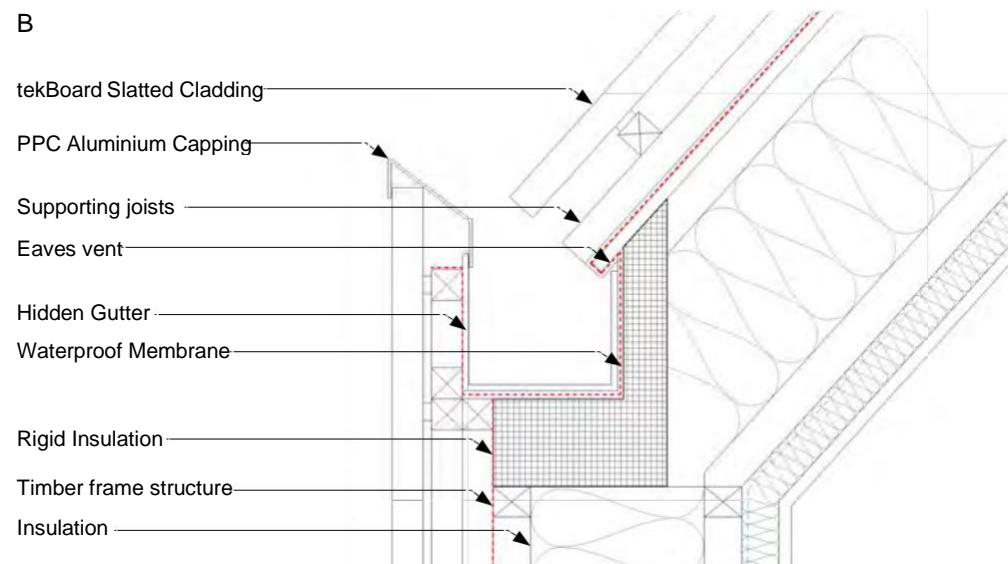

INSTALLATION - FACADE SYSTEM - ROOF

STEP 1

BUILD THE PRIMARY STRUCTURE

C Begin by building the primary structure for the building and install insulation as required.

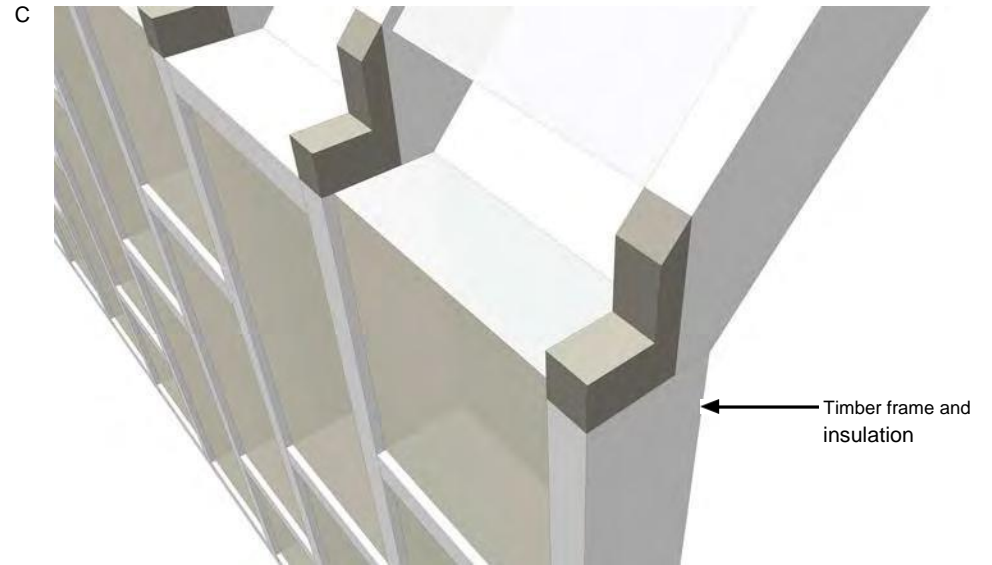

D Board out the roof and wall profiles as required. The majority of customers will use a ply sheet.

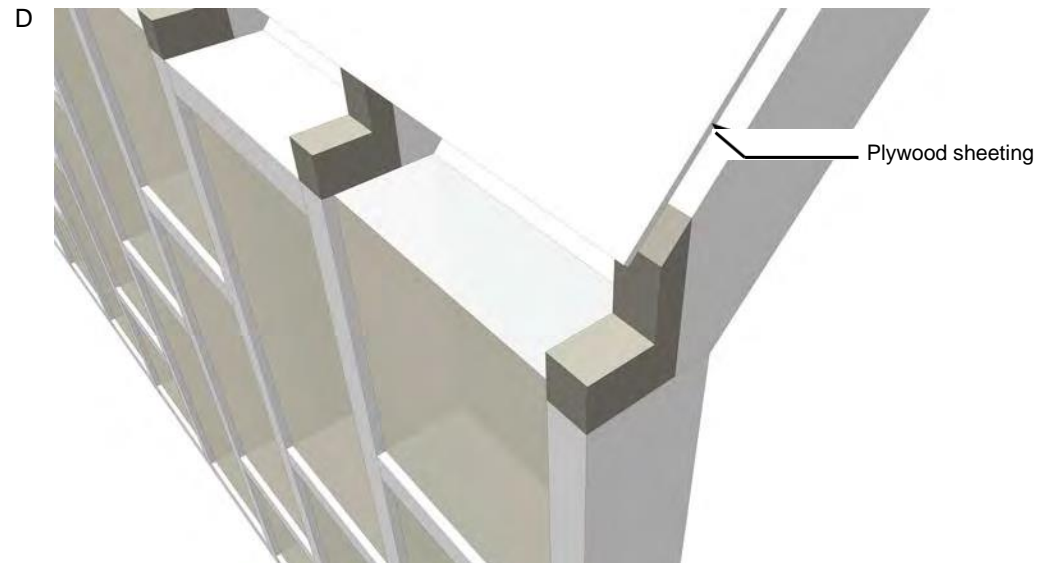

INSTALLATION - FACADE SYSTEM - ROOF

STEP 2

WATER PROOF AND INSTALL SECONDARY STRUCTURE

E Install the waterproof membrane in line with manufacturers details.

Ensure all surfaces and edges are waterproofed adequately. Contact a specialist if you are unsure. Ensure roof ventilation is also detailed and installed to the relevant standards.

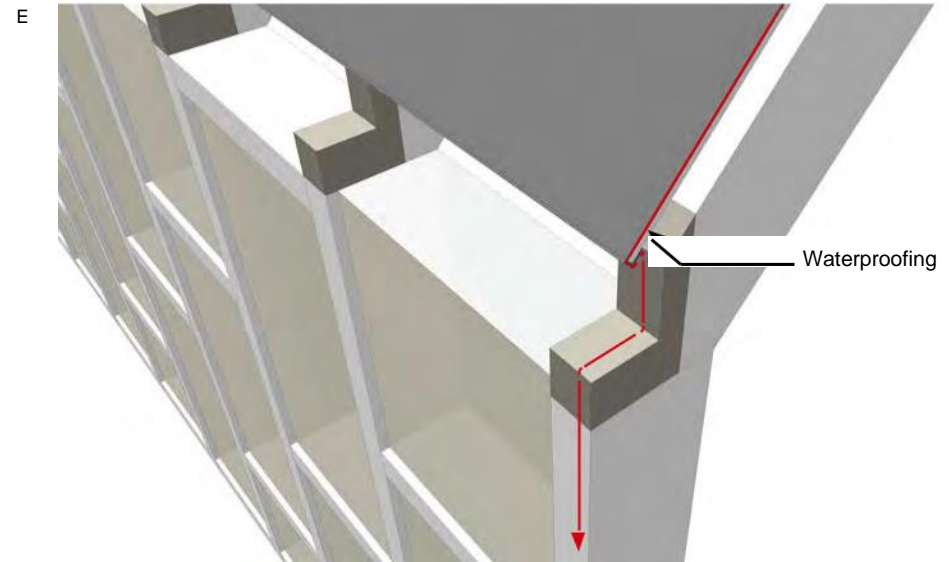

F Install the gutter profile and timber joists. Similar to the cladding steps earlier this can either be either treated timber or Aluminium joists.



INSTALLATION - FACADE SYSTEM - ROOF

STEP 3

INSTALL THE CLADDING BOARDS

G Install the cladding boards as required.

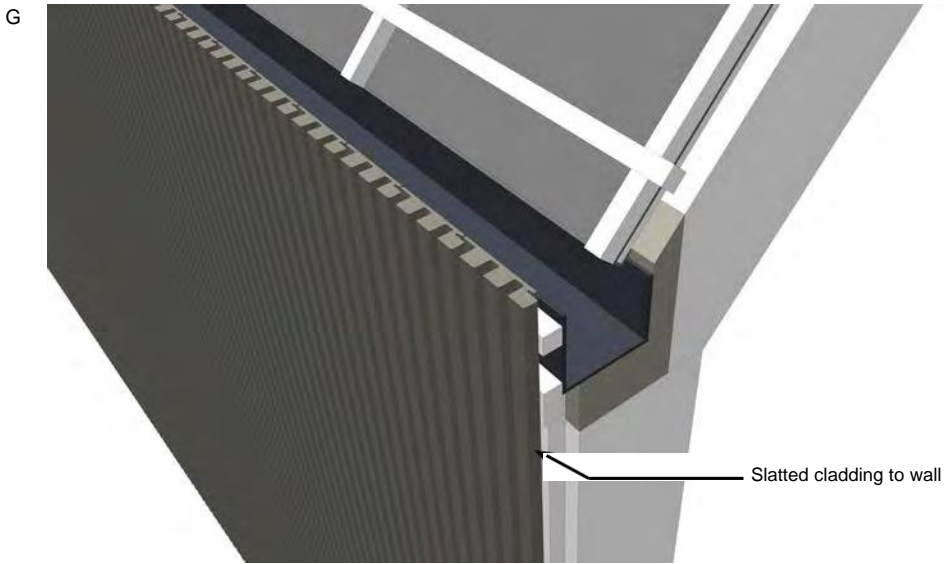

H Roof cladding boards can be aligned with the facade to give a clean Architectural finish.

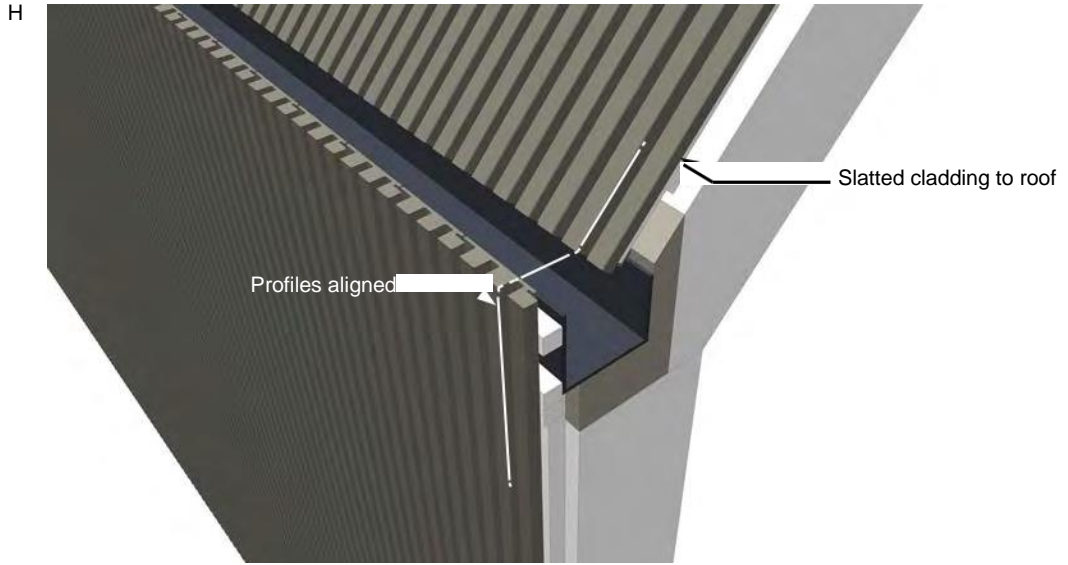

INSTALLATION - FACADE SYSTEM - ROOF

STEP 4

ADD ANY FINISHING DETAILS

- I Aluminium flashing can help finish the detail and ensure a weather proof edge to the gutter detail.

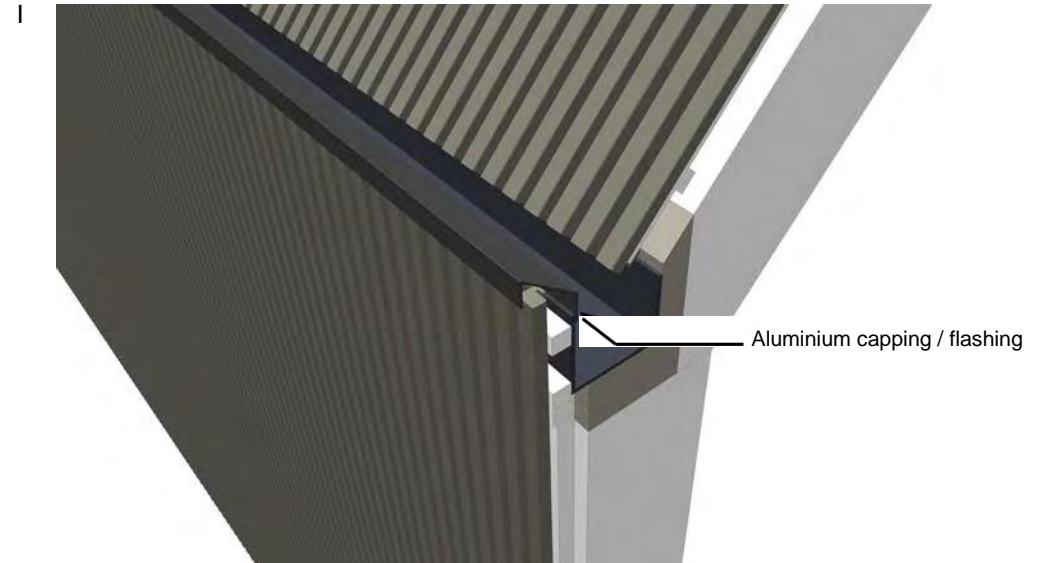

- J Job Done!

For further technical assistance please contact the tekBoard team.



INSTALLATION - SCREEN OR PLANTER

STEP 1

INSTALL STRUCTURE AND TRIMS

- A Our Slatted Cladding also works great as a screening element, in the garden or elsewhere. In this example we will show how to use the cladding boards to create a planter.

Install an appropriate sub-frame using either timber or solid plastic joists. Joists should be spaced at 500mm centres minimum, with posts fixed to concrete footings at min 1500mm centres. Please ensure you use appropriate footings - post mix or similar.

Please seek advice on structural installation if unsure. tekBoard cannot take any responsibility for poorly erected sub-frames or structures.

A

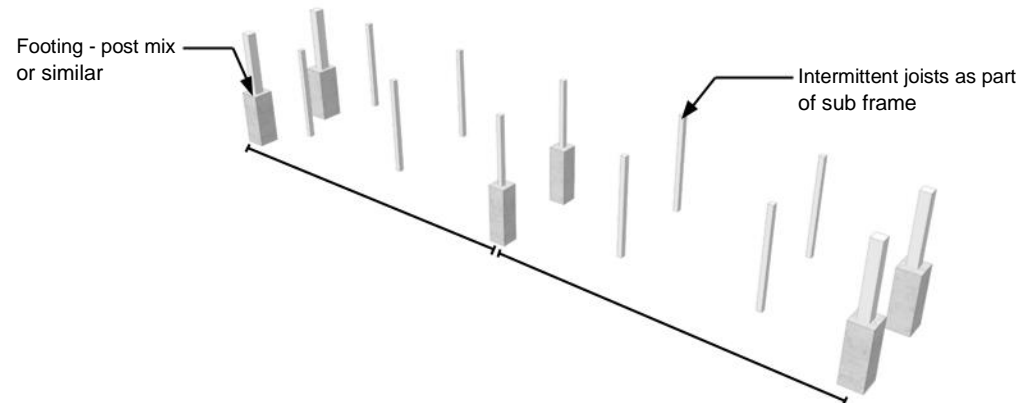

- B Install the corner trims to the posts / frame. Like the facade method, it is recommended that each full section is completed in turn to help with consistency.

B

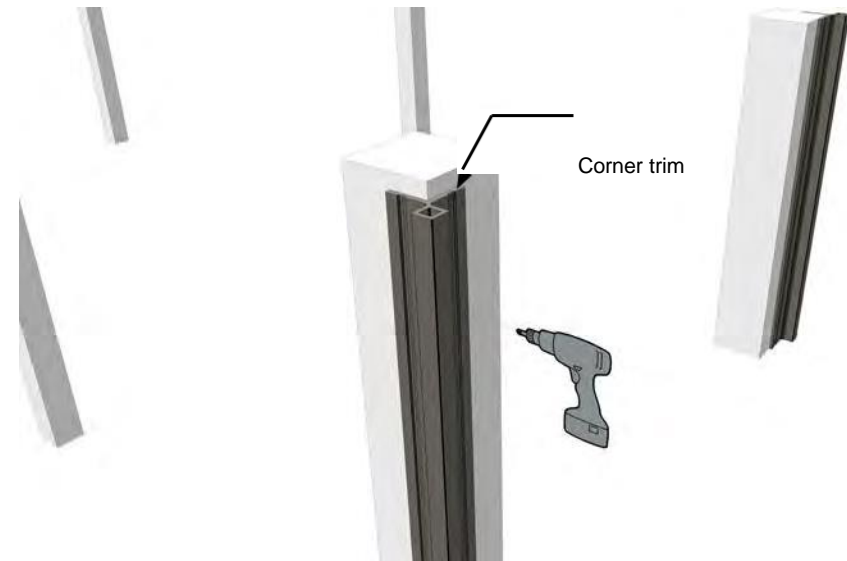

INSTALLATION - SCREEN OR PLANTER

STEP 2

INSTALL THE END TRIM AND STARTER BAR

- C If required install the end trims. Ensure you have calculated the number of boards and distance to avoid unnecessary cutting.

Note, all trims can be cut using standard wood working tools.

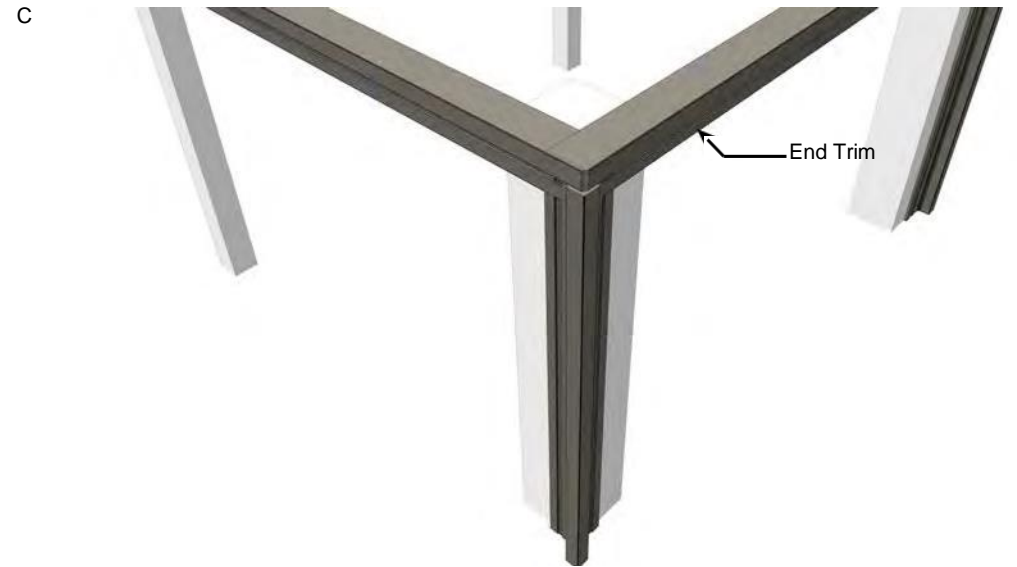

- D Install the starter bar into the base of the sub-frame. Ensure sufficient space is left so that the bottom cladding board will be a min 15mm from the ground.

Ensure the starter bar is horizontal and secured using the supplied aluminium screws.

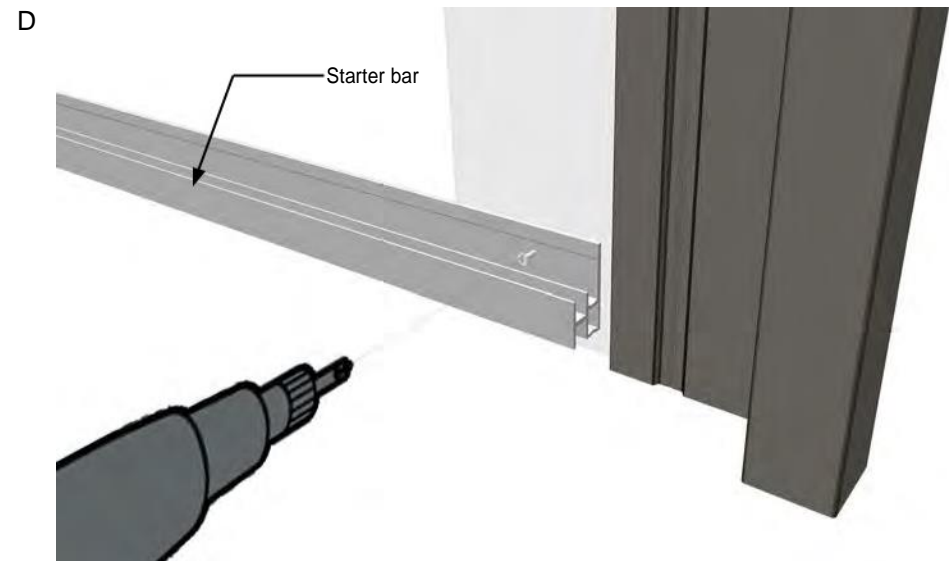

INSTALLATION - SCREEN OR PLANTER

STEP 3

INSERT THE FIRST CLADDING BOARD

- E Side the first board in place. Ensure the gaps to the corner or end trims as shown on page 17.

Ensure a gap is left between the end and cladding board as shown in page 54



- F Install the cladding clips as shown previously.

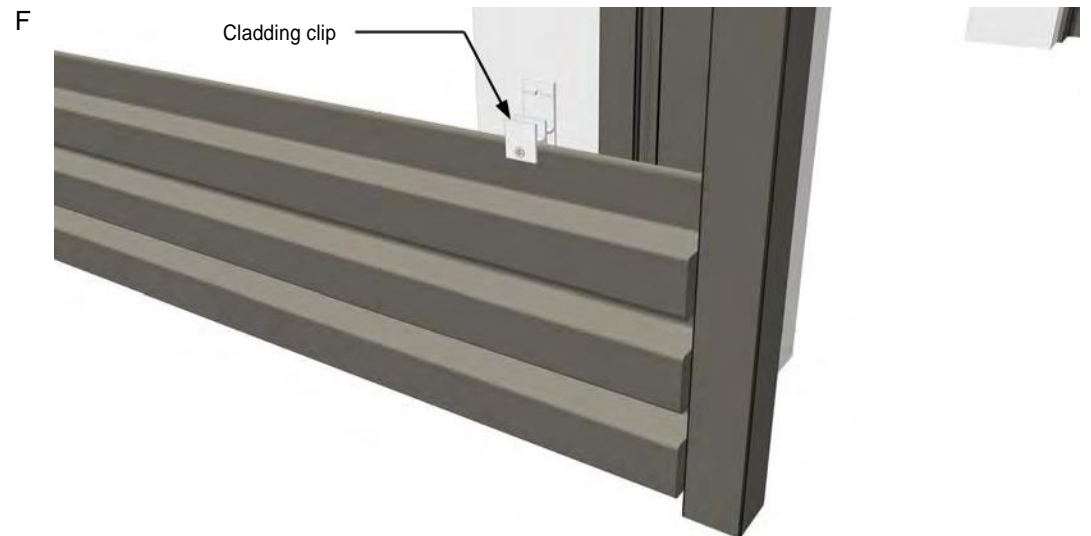

INSTALLATION - SCREEN OR PLANTER

STEP 4

COMPLETE THE REST OF THE SCREEN OR PLANTER

- G Install the remaining boards and secure the top boards in place using the colour coded screws, pre-drilled and counter sunk.

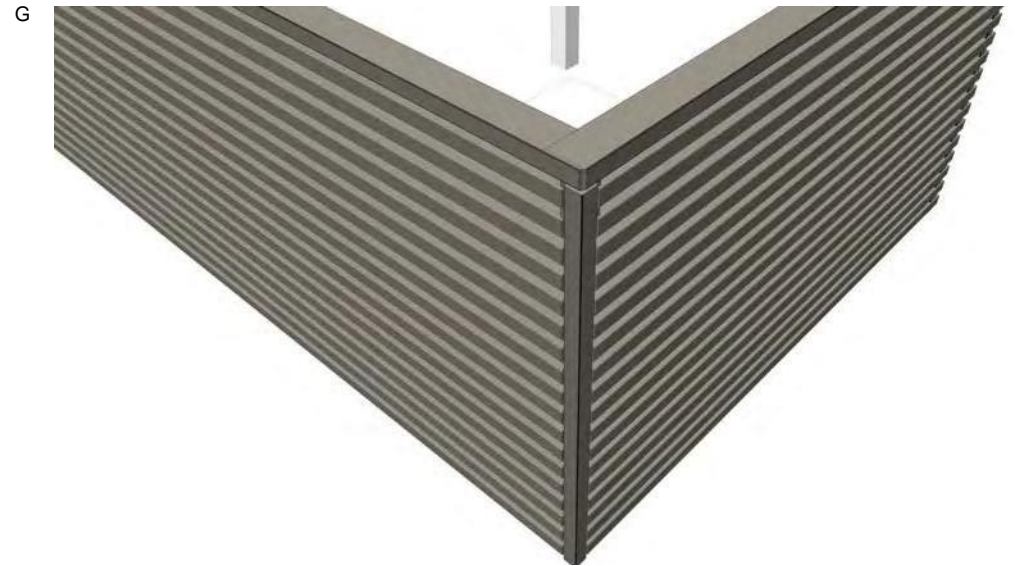

- H Now line the planter with a suitable base / side walls or drop in a steel or plastic liner. Add any waterproofing or drainage material required.

Note that our Slatted cladding should not be used as a retaining element for soil.

Boards can also be installed vertically too!

H



CLEANING AND CARE

Our Slatted Cladding boards will require periodic maintenance to remove the build up of dirt and debris. We recommend the cladding is cleaned once or twice a year using either:

- A high pressure cleaner (Jet wash) with a fan shaped beam at a distance of at least 20cm in a lengthwise direction, or;
- Scrubbing brush with a all-purpose cleaner and water

Burn marks, from BBQ's or similar can also be removed using a course piece of sandpaper (80gsm or similar), by rubbing the cladding length-ways gently.

EXPANSION GAP TABLE

Please refer to the table below when installing the cladding boards to determine the gap (mm) between boards and adjacent structures.

Please note this table covers expansion and contraction values for UK, Europe

		Length (Meters)									
		1	2.44	2.8	3	3.66	3.9	4	4.88	5.4	
Installation Temperature (°C)	-10	2.4	5.9	6.7	7.2	8.8	9.4	9.6	11.7	13.0	Gap (mm)
	-5	2.2	5.4	6.2	6.6	8.1	8.6	8.8	10.7	11.9	
	0	2.0	4.9	5.6	6.0	7.3	7.8	8.0	9.8	10.8	
	5	1.8	4.4	5.0	5.4	6.6	7.0	7.2	8.8	9.7	
	10	1.6	3.9	4.5	4.8	5.9	6.2	6.4	7.8	8.6	
	15	1.4	3.4	3.9	4.2	5.1	5.5	5.6	6.8	7.6	
	20	1.2	2.9	3.4	3.6	4.4	4.7	4.8	5.9	6.5	
	25	1.0	2.4	2.8	3.0	3.7	3.9	4.0	4.9	5.4	
	30	0.8	2.0	2.2	2.4	2.9	3.1	3.2	3.9	4.3	
	35	0.6	1.5	1.7	1.8	2.2	2.3	2.4	2.9	3.2	
	40	0.4	1.0	1.1	1.2	1.5	1.6	1.6	2.0	2.2	

